

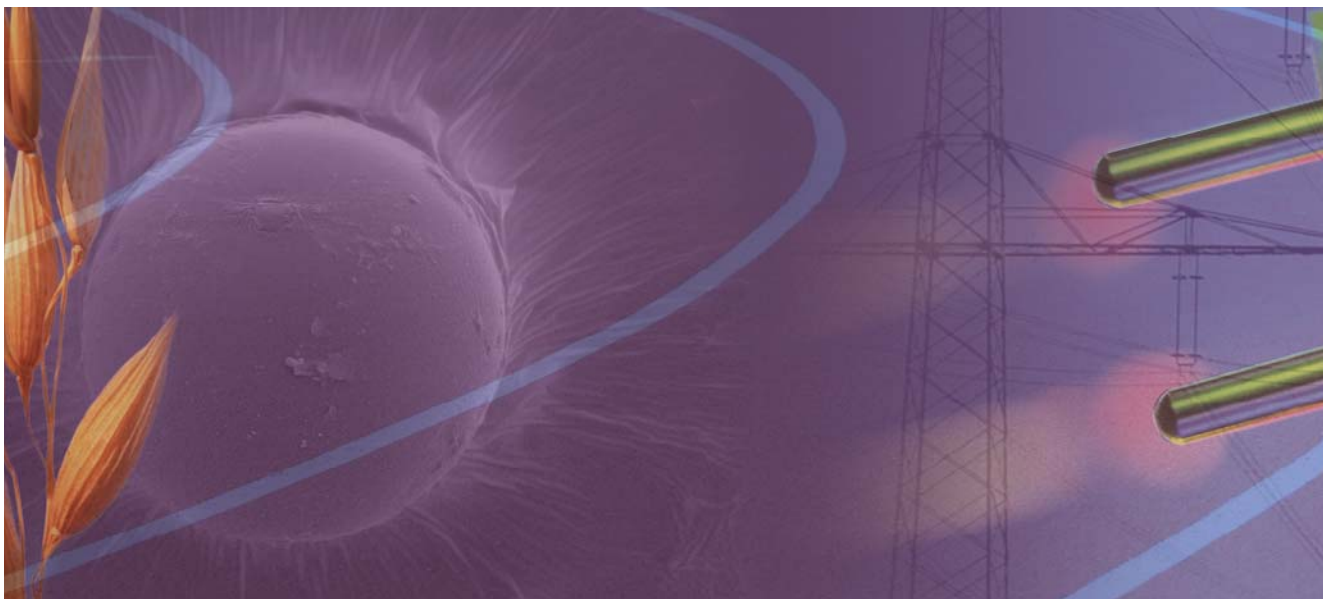

**Fraunhofer** Institut  
Umwelt-, Sicherheits-,  
Energietechnik UMSICHT

# 2005



## Annual Report

**Fraunhofer UMSICHT –  
Technology that pays!**

Key Research Area

## Biorefinery

Products from  
Renewable Resources



Key Research Area

## Matfunc

Particles, Materials  
and Membranes  
with Functionality

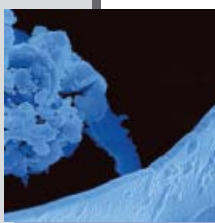

Key Research Area

## Modular Energy Technologies

Flexible Solutions for  
Sustainable Energy Systems



Key Research Area

## Information Networks for Process and Energy Technology

Utilizing Dispersed  
Knowledge in Value  
Added Chains

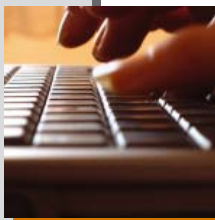

# At a Glance: Organizational Chart





**Fraunhofer** Institut  
Umwelt-, Sicherheits-,  
Energietechnik UMSICHT

# 2005

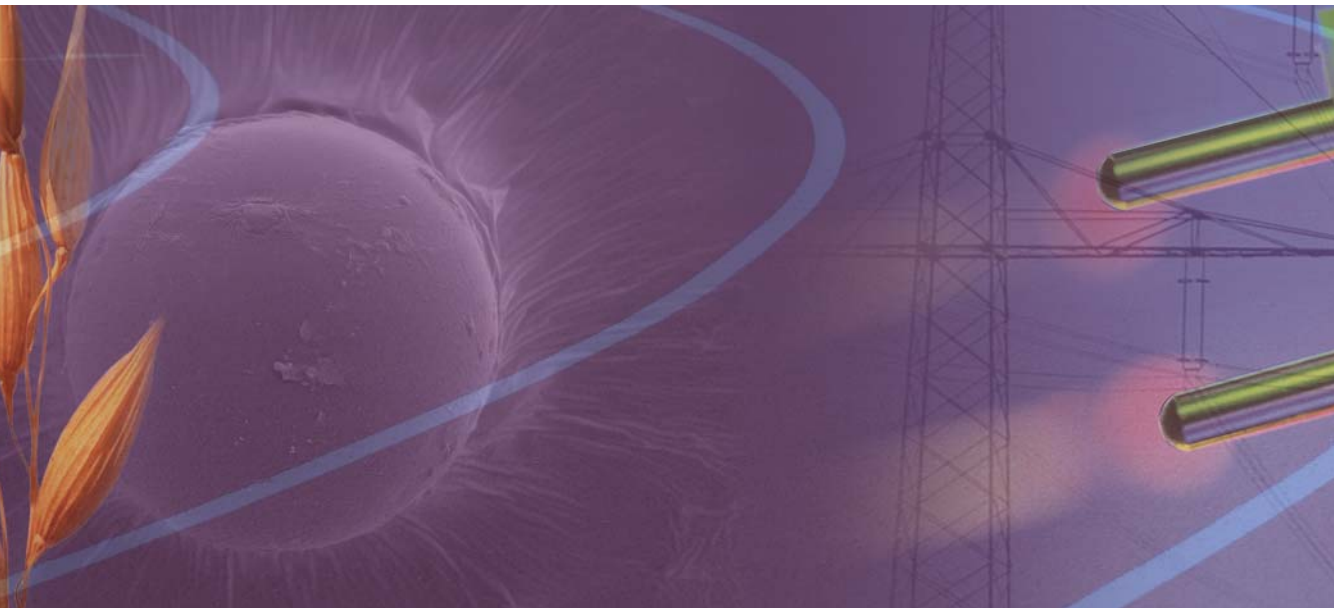

## Annual Report

# Contents

## ■ The Institute ■

Preface	4
Highlights 2005	6
The Fraunhofer Institute for Environmental, Safety, and Energy Technology UMSICHT	8
At a Glance: Facts and Figures	9
Key Research Areas: Innovation with Perspective!	10
Business Units	16
In Dialogue with Dr.-Ing. Volker Heil	20
infernum and TheoPrax®	23
Chemistry and Analytics	24
Biotechnological Laboratory	25
Marketing, Communication, Business Development	26
IT Management	27
Central Technical Services	28
Library	29

## ■ Business Unit Renewable Resources ■

Modeling of Enzyme Catalyzed Processes	32
Succinic acid – Basis of Future Biorefineries	33
Material Development for the Plastics Industry	34
Service Spectrum for Biogas Technology	35

## ■ Business Unit Process Technology ■

Optimization of Bubble Column Reactors	38
Technology with Holes: Microsieves for Filtration Technology Applications	39
Impregnation of Wood with Supercritical Carbon Dioxide	40
Naturally Healthy Thanks to Membrane Technology	41

## ■ Business Unit Waste Management/ -Technology and Adsorption ■

Energetic Utilization of Refuse Derived Fuels and Waste	44
Characterization of the Combustion Attributes of Refuse Derived Fuels (RDF)	45
BioRegio: Strategies for the Sustainable Energy Use of Biomass	46
The greasoline® Process concept: Production of Biogenous Fuels from Waste Grease	47

## ■ Business Unit Advanced Materials ■

Biomimetics as the Technology Vision of the Future?	50
Swellable Thermoplastic Elastomer Composites Q-TE-C®	51
System Analysis of Reacting Fluidized Beds	52
ParMa: Laboratory for the Parallel Synthesis of Particulate Materials	53

## ■ Business Unit Safety Engineering ■

Fire and Explosion Protection	56
SAFETYprove: Efficient Fusion of Operational Management Systems	57
Fast and Safe Closing of Control Devices: Pressure Control Device (PCD)	58
Solutions for the Simulation of Heat Transport and Material Flow	59

## ■ Business Unit Energy Technology ■

Polygeneration with the TRIG Process	62
Exploratory Drilling for Coal Mine Gas Recovery	63
Alternatives for the Generation of Biofuels	64
Generation, Treatment, and Supply of Biogas – Analysis and Evaluation	65

## ■ Business Unit Energy Systems ■

Energy Benchmarking: More than a Number	68
Thermal Chillers for Solar Cooling and Combined Heat, Cold, and Power Generation	69
Decision Support for the Energy Management	70
Coolants in a Class of their Own	71

## ■ Business Unit Know-how and Technology Transfer ■

Network for Gas Treatment Technologies and Processes “ReGasNet”	74
European Waste Sector Assistant EUWAS	75
Working Group for Applied Activated Carbon Technologies (AFATEC)	76
Support of Research Cooperation within the EU	77

## ■ Names, Data, Events ■

Publications	80
Selected Clients and Contacts	81
Patents	84
Spin-offs	85
How to Find us	86
Guidelines	87
The Fraunhofer-Gesellschaft	88
Board of Trustees	90
Imprint	91



Birthdays are wonderful. One can celebrate them, but they may lend themselves even better for a resume and for a look back to the years gone by. Fraunhofer UMSICHT turned 15 years old. We celebrated with a look towards the future.

What will the next years bring? It is clear that humans want to satisfy their needs for nutrition, raw materials, energy, and information in the future. Fraunhofer UMSICHT wants to lay the groundwork for achieving that and is strengthening its technological profile for tomorrow.

Therefore, we developed visions. In order to realize them, we are stringently working in new scientific directions. Thus, we find it realistic that 20 % of chemicals, materials, and fuels will be produced in biorefineries from renewable resources in the year 2020. We are working on producing particles in any defined shape and complex structures, layers, and components that emerge through self organization. We are convinced that sustainable energy supply is vital for the growing world population. Decentralized plants, energy efficiency, and renewable energy will be crucial in getting there. We want to enable the provision of structured knowledge for the solution of complex technical problems possible at any time from any place.

These visions should become reality. "Biorefinery", "Functional materials", "Modular energy technologies", and "Information networks for process and energy technology" are the four key research areas with which Fraunhofer UMSICHT positions itself in the research landscape. We are well on our way of getting there: The perception of our "Institute on the move" is consistently receiving positive, external feedback. For example, the price recipients of the idea competition "Biomimetics – Innovation from Nature" of the Federal German Ministry for Education and Research garnered national attention for their cutting tools based on nature's principle of self-sharpening incisors. Six million times were tableware and cutlery made from bioplastic, co-developed by UMSICHT, handed out at the 20<sup>th</sup> World Youth Day in



Cologne and enthused the attendants about products from renewable resources. The survey research institute TNS asked local, renowned scientists from the natural and engineering sciences about the best research establishments in Germany. We are happy that the surveyed individuals put Fraunhofer UMSICHT at the top of the list in the field of energy technology. The interdisciplinary distance learning program for environmental sciences (infernium), started in cooperation with the Open University in Hagen, is proud to carry the title "Official project of the decade of the United Nations for the education of sustainable development 2005 – 2014". Concurrently, it was integrated into the Technology Academy of the Fraunhofer-Gesellschaft as a part of an exclusive continued education program for executives.

My sincerest appreciation goes out to the employees of the institute who have gone down into scientific directions with great enthusiasm and are moving them forward with much commitment and talent. I also thank our business partners and customers, the members of the UMSICHT board of trustees and the circle of friends and patrons, as well as all supporters from the EU, state, and federal ministries, and the project executing organizations for their constructive support.

We present to you an excerpt of our minor and major successes with our annual report of 2005. It reflects the new capabilities of the institute and hints where the journey will take us in 2006. I would be delighted if our visions convinced you to work with us on their realization in the future. Your feedback to our ideas and your active support is a fundamental requirement in order to continue to successfully master the upcoming challenges.

I wish you an inspiring read.

Your



Eckhard Weidner  
Director Fraunhofer UMSICHT



Tremendous interest in decontamination and disinfection during fire response brings 270 participants from all over Germany to the fire department symposium BrandO. to Oberhausen in May 2005.

## Highlights 2005

Rat-sharp cutting tools based on nature's principle of self-sharpening incisors are being developed by Jürgen Bertling and Marcus Rechberger. In March, they are awarded a price by Minister Edelgard Buhlman as part of the idea competition "Biomimetics – Innovation from Nature" from the German Ministry for Education and Research BMBF.



The new plastic material Q-TE-C® adds a swellable variant to the material class of thermoplastic elastomers. Potential applications in the sealing technology field are being presented in April at the IFAT in Munich.





Group picture with three directors of the institute: Prof. em. Paul-Michael Weinspach, Prof. Eckhard Weidner and Prof. Rolf Kümmel are meeting in June and celebrating the 15<sup>th</sup> birthday of the institute with friends and supporters over some coffee and cake.



Convinces the jurors of the IT-Apprentice-Competition JOY "Junior of the Year" of the Dortmund-project with her final project: Christine Czernek is being awarded in July for the software "Peakfinder" she has developed.



Honor where honor is due: In September during his farewell, Professor Dr. Rolf Kümmel received the Fraunhofer Medal for his contribution on the advancement of the institute from institute custodian Helmut Selinger.



Fraunhofer UMSICHT striving for the pole position in the field of biorefineries. In September, the visitors of the 5<sup>th</sup> Munich Science Days are learning how renewable resources are getting from the field to industry via the biorefinery.

## The Fraunhofer Institute for Environmental, Safety, and Energy Technology UMSICHT

The industrial nations of today owe their convenient living conditions to the, at all times, sufficient production of economic goods, the secure production and distribution of energy, as well as the free exchange of information.

Production and consumption are embedded in an economic system, which presupposes economic growth and competition and an ecological system whose absorption and provision capacities are limited.

## Fraunhofer UMSICHT

Which makes apparent: Technological progress is the engine for every modern industrial society. Technological innovations help making efficient and safe use of resources and energy resources. They allow a satisfactory and inexpensive production of innovative goods and create and secure competitive jobs.

In this context Fraunhofer UMSICHT develops and researches the latest knowledge and transfers it into industrial applications and marketable products.

Eight specialized business units are the basis for the institute's multi-faceted, development competence in process engineering. Thus, the institute can serve as a one-stop-shop for its clients.



**Fraunhofer UMSICHT –  
Technology, that pays!**

Whether the customer is a small or medium-sized company, a major enterprise or a public institution, the institute's motto applies to all of them:

**Fraunhofer UMSICHT –  
Technology that pays!**

As a member of the Fraunhofer-Gesellschaft the institute follows the tradition of applied research and development, close to the market.

As a catalyst for science and economy, Fraunhofer UMSICHT engages in the structural change of the city and the region with new ideas, technology transfer, spin-offs and the formation of R&D networks.

Internationally, the institute operates in the states of central and Eastern Europe, in the Americas as well as in Asian countries.

## Staff

Staff at Fraunhofer UMSICHT 2005 Number

<b>Permanent Staff</b>	<b>137</b>
- Scientists and engineers	87
- Technical Infrastructure	28
- Central Services	22
<b>Other Staff</b>	<b>93</b>
- Postgraduates	10
- Undergraduates	10
- Student assistants	47
- Interns, guest scientists	18
- Trainees	8
<b>Total Staff</b>	<b>230</b>

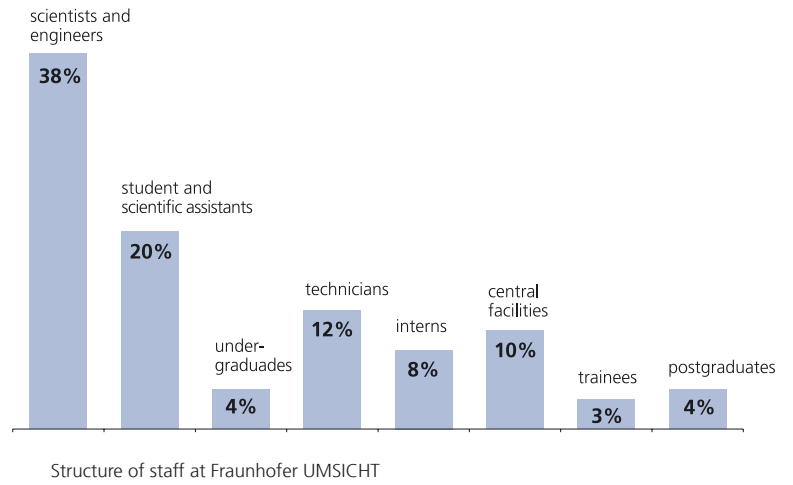

## Expenditure and returns

Expenditure 2005 (m €)

<b>Operational Budget</b>	<b>19.6</b>
- Staff costs	7.8
- Other costs	11.8

**Investments** **0.8**

Returns Operational Budget 2005 (m €)

- Industrial returns	9.1
small and medium-sized enterprises	6.6
large enterprises	2.5
- Public returns	2.9
- Others (EU, communities)	0.8
- Basic funding	6.8
<b>Total Returns</b>	<b>19.6</b>

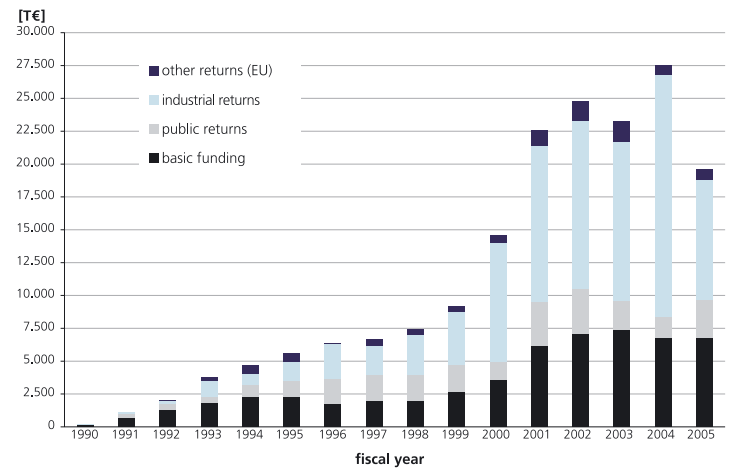

Development of the operational budget since the establishment of the institute

# Key Research Areas

---

Biorefinery

Matfunc

Modular Energy Technologies

Information Networks for Process and Energy Technology

“Biorefinery”

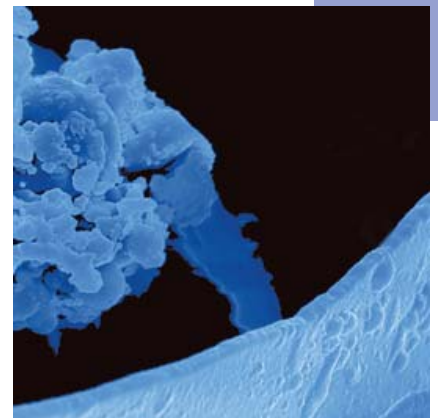

“Matfunc”

In this day and age, business strategy means to meet challenges in the face of increasing change. Growing resource conflicts, a flood of information and knowledge, aging societies, globalization, and climate change are all factors that influence our society and markets. What was frowned upon yesterday could become economically, environmentally, and politically attractive tomorrow and turn into a competitive advantage.

Fraunhofer UMSICHT sees itself as a forerunner for technological change in the areas of environmental, energy, process technology and safety. The institute advances sustainable economizing, environmentally friendly tech-

nologies, and innovative activities in order to improve the quality of life for humans.

Four key research areas form the strategic foundation for the technological positioning of the institute in the German and international research landscape. The key research areas are to be seen as scientific impulses for overarching business units. With them, the profile of the institute is adapted to the rhythm of economic and social change and focused on promising research directions.

#### Your contact

Dr.-Ing. Görgo Deerberg  
(+49 2 08/85 98 -11 07)



**“Modular  
Energy  
Technologies”**

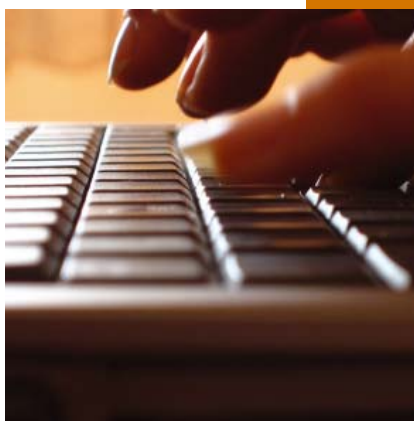

**“Information  
Networks for  
Process and Energy  
Technology”**

# Key Research Areas

## Key Research Area

### “Biorefinery”

#### Products from Renewable Resources

Sustainable management is a growing social need. In few places does it enjoy greater acceptance than in the areas of raw material supply for plastic products and energy generation. Based on the developments in the petroleum market, medium and long-term substitutes as well as strategies and technologies for the diversification of the raw material basis are necessary. Our vision that 20% of chemicals, materials, and fuels will be produced from renewable resources by the year 2020 is the logical consequence.

The chances for a sustainable restructuring of the raw material basis and a creation of new export technologies are favorable for the technology center Germany.

The recipe for success of petroleum technology is basically simple: Low-cost mass products such as fuels are produced in combination with high priced and high quality products for the chemical industry.



The idea of the biorefinery uses this concept and transfers it for the utilization of renewable resources. Due to the variety of potential bio-based raw materials and logistic restrictions, there will never be the “one” biorefinery. Fraunhofer UMSICHT is developing concrete process chains that are synergistic with regard to economical and environmental aspects. These developments are product driven and should realize an economical co-production »from field to product« with technologies that are individually synchronized with each other. In addition to the development of plastics from cellulose acetate, polylactic acid, and succinic acid, new technologies for the production of biodiesel including the utilization of byproducts and the coproduction of »real« diesel and ethanol from biomass are focal points of our projects. The addition of laboratories for the development of bio-based processes and plastics has put UMSICHT in a position to be an active participant of the realization of the vision.



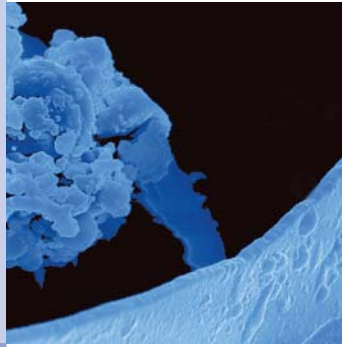

## Key Research Area

### “Matfunc”

#### Particles, Materials and Membranes with Functionality

Switchable materials, adaptive materials, memory materials, and self organizing materials are the basis for innovations in the fields of communication technologies, mobility, and medicine that promise great advances. New materials with yet unknown applications can become reality by employing functionalized surfaces and intelligent materials.

For example, certain polymer components can add self-healing abilities to injection molding compounds. Such new functionalities increase the attractiveness of products and contribute to resource and cost savings. Similar applications are sensible in many areas of the food industry. Work pieces that,

aside from their original purpose, perform additional functions such as changing their shape, acting as sensors or actuators, conducting or storing electricity, changing their coloration or tribologic characteristics, and forming highly selective membranes and microsieves with uniform pore structures based on varying ambient conditions are examples of promising new products and processes.

In this highly innovative field, Fraunhofer UMSICHT offers technologies for the manufacturing and packing of membranes, microsieves, and especially particulate materials which support application and product development.

The vision that even the smallest particles can be produced in any defined shape, and that complex structures, layers, and components can emerge through self organization is defining the path to the future.

The foundation for this was started by building a particle synthesis laboratory in addition to a membrane and micro-sieve laboratory.



## Key Research Area

# “Modular Energy Technologies”

### Flexible Solutions for Sustainable Energy Systems

Sustainable energy supply is vital for the growing world population. Decentralized plants, energy efficiency, and renewable energy will be crucial in getting there!

Costs, supply security, and climate protection are the drivers for the transformation of the energy sector. Decentralized concepts can help to efficiently utilize locally available, renewable resources. In addition to the ability to integrate into existing infrastructures, it has to be economically viable. Based on the quickly changing boundary conditions, the market necessitates flexible solutions for a sustainable energy economy. The decentralized generation of energy from biomass and recycled materials in combination with polygeneration processes can fulfill these requirements. Based on electricity generation with combined heat and power plants, microturbines, or eventually fuel

cells, waste heat can be directly utilized or converted into cold via thermal chillers (combined heat power and cold generation CHPC). In addition, lower range waste heat can be exploited via the Organic Rankine Cycle (ORC) to further increase efficiency.

Aside from the global demand for electricity and heat, some regions including areas of Europe are experiencing an increase in the demand for cold for air conditioning. Decentralized CHPC technologies are the key to cover the demand in a sustainable manner.

Accordingly, Fraunhofer UMSICHT has added relevant technologies and gained further expertise so that Fraunhofer internal research projects could be initiated and started with governmental and industrial contractors. So that, for example, the utilization of low BTU, landfill, and sewage gases as well as feeding biogas into the grid could be developed in collaborative projects. In-house preliminary work consisted of developing the principles of small-scale thermal chillers. These are currently developed further in a Fraunhofer internal project for room air conditioning.

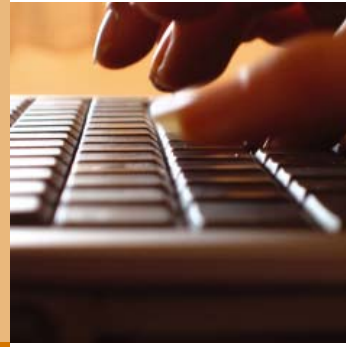

## Key Research Area

### “Information Networks for Process and Energy Technology”

#### Utilizing Dispersed Knowledge in Value Added Chains

“Knowledge is power” goes the saying. “And safety, money, and sustainability” should be added to it.

In complex production systems as they exist today, the amount of information about business processes, workflows, and technical and scientific processes in plants and apparatuses is constantly expanding. Based on reasons of safety and economic efficiency, the following is often requested: The provision of structured knowledge for the solution of complex technical problems should be possible at any time from any place.

The production in networks is becoming more important in all industries. In the area of renewable resources,

especially, production systems such as biorefineries will require a continuous, reliable, and traceable supply of raw and support materials in the future. This necessitates coordination and control in order to couple raw material sources and production paths that result in economically and environmentally optimized productions and products. These aspects of the material flow management are addressed in addition to byproduct management and safety related questions.

In the context of the key research area, technologies and systems should be developed with which today's complex production systems can be planned and supported during operation. Examples for this were realized last year.

A municipality is supporting its power generation facility by using methods developed by Fraunhofer UMSICHT in terms of precisely planning and documenting the maintenance of plants and machines. Employees can quickly and efficiently be trained on safety through the continuously updated database of technical and regulatory information. This information is directly accessible at every workstation made available by Fraunhofer UMSICHT's DUBAnet®-System so that the employer fulfills his business obligation almost automatically.

## Our Business Units

Fraunhofer UMSICHT presents itself in the market for applied research with eight business units. These business units represent the tailor-made combination of products and R&D services with the requirements of the respective business segments. They apply modern methods of project management and realize successful innovation projects. At the same time they use research and science to advance the institute's key research areas "bottom up". The knowledge basis for maintaining and extending our core competencies lies within the business units.

Our staff is working in market-oriented and efficient teams in order to react to our customers' needs even more actively and flexibly. Just contact us and see for yourself!



### Business Unit Renewable Resources

Dr.-Ing. Stephan Kabasci  
 Phone: +49 2 08/85 98 -11 64  
 Fax: +49 2 08/85 98 -14 24  
[stephan.kabasci@umsicht.fraunhofer.de](mailto:stephan.kabasci@umsicht.fraunhofer.de)

### Bioengineering

Synthesis of valuable material; reprocessing of biotechnological products; biogas production; biological wastewater, waste air, and solid waste treatment; enzymatic synthesis

### Plastics Technology

Material development: polymers from renewable resources, biodegradable polymers, wood fiber reinforced compounds, recycling; customer specific special blends; compounding; material, production, and recycling-oriented design; injection or extrusion prototypes, small scale production; mechanical and rheological testing; thermochemical and spectroscopic analysis

### Resource-efficient Products

Biorefinery systems; market and technology studies; recycling concepts; product development



### Business Unit Process Technology

Dr.-Ing. Gorge Deerberg  
 Phone: +49 2 08/85 98 -11 07  
 Fax: +49 2 08/85 98 -12 90  
[goerge.deerberg@umsicht.fraunhofer.de](mailto:goerge.deerberg@umsicht.fraunhofer.de)

### Membrane Technology

Application and process development for membranes and microsieves; manufacturing and characterization of microsieves; process media cleaning; downstream processing, wastewater technology and water reutilization; specialty applications in the food, and biotech industry

### High-pressure Technology

Utilization of supercritical fluids for the extraction of contaminants and additives, impregnation and as reaction medium for chemical and enzymatic syntheses; decontamination of cultural treasures; improvement of wood properties

### Reaction Technology

Process development and optimization of multi-phase processes in chemistry and biotechnology; process modeling and simulation; development and application of simulation and optimization software; CFD; process control safety equipment and pattern recognition



### Business Unit Waste Management/-Technology and Adsorption

Dr. rer. nat. Kai Keldenich  
 Phone: +49 2 08/85 98 -11 67  
 Fax: +49 2 08/85 98 -14 24  
 kai.keldenich@umsicht.fraunhofer.de

#### Waste Disposal Management

Thermal treatment/energetic utilization; optimization of thermal processes e.g. through CFD; mechanical and biological waste treatment; mobile confectioning (treatment/sampling and initial analysis on site); production and utilization of refuse derived fuels (RDF)

#### Material Flow Management

Closing of material and energy loops; benchmarking of technical systems based on standardized numbers; simulation of waste treatment processes; generation of cost/benefit analyses for decision-making; ecological and economic optimization of disposal networks

#### Sorption Technology

Flue gas cleaning; gas washing and adsorption; gas cleaning for sewage treatment plants, landfills, digesters; conversion of gaseous airborne contaminants; development and characterization of high performance adsorbents in own tubular rotary kiln pilot plant stations; determination of material and process data for sorption processes; examination of activated carbon filters for motor vehicles; modeling of adsorption processes; recovery of solvents; air separation



### Business Unit Advanced Materials

Dipl.-Ing. Jürgen Bertling  
 Phone: +49 2 08/85 98 -11 68  
 Fax: +49 2 08/85 98 -14 24  
 juergen.bertling@umsicht.fraunhofer.de

#### Smart Materials

Thermophilic hydro gels; self-repairing sealing systems; immobilized catalytic converters; micro encapsulation with indicators, latent heat storage, etc.; micro hollow spheres for weight minimization; surface modified pigments; effect pigments; self sharpening cutting tools developed according to biomimetic principles

#### Particle Technology

Comminution (cryogenic/ambient); spray-drying, micro encapsulation; separation; rotating tube or fluidized bed technology; compounding; recycling

#### Analytics/Modeling

Modeling of particle formation processes and multi component material transport; model based process optimization and control; particle technology data processing and visualization; methods; CFD; population discrete elements method; artificial neural networks



### Business Unit Safety Engineering

Dr.-Ing. Stefan Schlüter  
 Phone: +49 2 08/85 98 -11 26  
 Fax: +49 2 08/85 98 -14 25  
 stefan.schlueter@umsicht.fraunhofer.de

#### Fire and Explosion Protection

Fire and explosion protection; explosion protection documents; plant safety; fire safety concepts; smoke testing processes

#### Information Management

Electronic assistant systems; information management; document management; documentation of safety policies; state of the safety technology

#### Hydraulic Systems

Pipeline technology; pipeline test area; cavitation resistance; fittings and component testing; dynamic simulation of pipeline networks



### Business Unit Energy Technology

Dr.-Ing. Markus Ising  
Phone: +49 2 08/85 98 -11 89  
Fax: +49 2 08/85 98 -14 23  
markus.ising@umsicht.fraunhofer.de

#### Gasification, Gas Upgrading

Gas capture and extraction (e.g. coal mine gas); gas treatment (adsorption, reforming); gas separation technology (oxygen enrichment, methane enrichment, CO<sub>2</sub>-separation); low BTU gases (e.g. coal mine gas, landfill gas, biogas, gasification gas); emission trading consulting (inventory, project design document [PDD], trading)

#### Energy Process Engineering

Combustion, gasification (e.g. of wood, RDF, sewage sludge); fluidized bed technology, grate firing, burner technology, heat transfer; retrofit (e.g. efficiency increase, fuel switch, emission reduction); pollutant, hot gas, and tar analysis; system modeling and analysis; process control

#### CHP – Combined Heat and Power Generation

Regenerative fuels; fuel cell analysis (PEFC, MCFC, SOFC) and hydrogen technology; decentralized heat and power generation (co-generation plants, micro and mini turbines); supply and utilization concepts, economics



### Business Unit Energy Systems

Dr.-Ing. Christian Dötsch  
Phone: +49 2 08/85 98 -11 95  
Fax: +49 2 08/85 98 -14 23  
christian.doetsch@umsicht.fraunhofer.de

#### Energy Economics and Management

Energy analysis and operational optimization of heat, cold, and electricity supply systems; energy economy and politics; electricity and CO<sub>2</sub>-trading; power plant application and resource optimization; risk management (deciding under uncertainty)

#### Sustainable Supply Systems

Generation of independent potential and feasibility studies incl. consulting; application of combined heat, cold, and power plants; grid simulation and operational optimization; virtual power plants; leak detection with dissolved helium

#### Cooling Technologies

Thermal cooling processes: steam jet ejector chiller, absorption chiller; solar thermal chiller: air conditioning, product cooling; application of high-performance refrigerants (PCS, ice-slurries) and latent heat storage media (PCM/PCS); innovative cooling processes; cleaning of combustion gases (landfill gas, sewage gas)



### Business Unit Know-how and Technology Transfer

Dr.-Ing. Achim Loewen  
Phone: +49 2 08/85 98 -11 52  
Fax: +49 2 08/85 98 -12 89  
achim.loewen@umsicht.fraunhofer.de

#### International Projects

Organization, coordination, and execution of international joint research projects; organization of international research and development networks; consulting services for German and foreign ministries, municipalities and businesses; support for German companies with international acquisition and for foreign companies with activities in Germany; head office of the German-Polish research association INCREASE

#### Funding Programs

Identification of funding programs for internal and external customers; support in the application for national and international funds; organization of cooperation on a national and international level; adopting project management tasks

#### Technology Transfer

Identification of internationally marketable UMSICHT technologies; project identification; execution of and assistance with project development; finding business partners (small and medium-sized enterprises, funding partners, technology promoters); point of contact for technology scouts; implementation of pilot and demonstration projects

**Marketing, Communication,  
Business Development**

Dr.-Ing. Hartmut Pflaum  
 Phone: +49 2 08/85 98 -11 71  
 Fax: +49 2 08/85 98 -12 90  
 hartmut.pflaum@umsicht.fraunhofer.de



Dipl.-Chem. Iris Kumpmann  
 Phone: +49 2 08/85 98 -12 00  
 Fax: +49 2 08/85 98 -12 90  
 iris.kumpmann@umsicht.fraunhofer.de

Innovation management and marketing; business area planning; market and technology studies; composition and layout of printed media; media work; press and public relations; information medium internet; marketing concepts; strategy; intellectual property rights; project development

**Occupational Safety and Environmental  
Protection**

Dr.-Ing. Ulrich Seifert  
 Phone: +49 2 08/85 98 -11 27  
 Fax: +49 2 08/85 98 -12 90  
 ulrich.seifert@umsicht.fraunhofer.de

Coordination and advice in topics related to occupational safety: vocational training and on-the-job courses; registration and notification procedures; monitoring of legislative regulations

**IT Management**

Dipl.-Ing. Andreas Schröder  
 Phone: +49 2 08/85 98 -11 31  
 Fax: +49 2 08/85 98 -12 90  
 andreas.schroeder@umsicht.fraunhofer.de

DP-auditing; planning, installation and operation of local networks; conception of central data management and security; data base development; developments of web applications; client server solutions; system architecture

**Laboratory**

Dr. rer. nat. Thomas Marzi  
 Phone: +49 2 08/85 98 -12 30  
 Fax: +49 2 08/85 98 -14 24  
 thomas.marzi@umsicht.fraunhofer.de



Dr. rer. nat. Ute Merrettig-Bruns  
 Phone: +49 2 08/85 98 -12 29  
 Fax: +49 2 08/85 98 -14 24  
 ute.merrettig-bruns@umsicht.fraunhofer.de

Biotechnology; organic analysis, inorganic analysis; chemical-physical measurement methods; fuel characterization; refuse derived fuels; waste analysis; environmental chemistry; ashes, slag, compost, endocrine materials, landfill and biogas

**Training Center**

Dipl.-Ing. Anja Gerstenmeier  
 Phone: +49 2 08/85 98 -11 11  
 Fax: +49 2 08/85 98 -12 90  
 anja.gerstenmeier@umsicht.fraunhofer.de

Knowledge and know-how transfer; interdisciplinary distance study program environmental sciences (infernum); practical training at schools and universities; blended learning; seminars; workshops; personnel development

**Administration**

Dipl.-Betriebsw. Andreas Weber  
 Phone: +49 2 08/85 98 -12 26  
 Fax: +49 2 08/85 98 -12 90  
 andreas.weber@umsicht.fraunhofer.de

Budgeting; controlling; projects; personnel; research contracts; purchasing; accounting; business travel; infrastructure

**Central Technical Services**

Dipl.-Ing. Richard Sprick  
 Phone: +49 2 08/85 98 -11 82  
 Fax: +49 2 08/85 98 -12 90  
 richard.sprick@umsicht.fraunhofer.de

Plant construction; project management; basic und detail engineering; sampling, analytical and pilot programs; technical service; central implementation of measurement and control, process control system implementation; operating technology center; mechanical and electronic workshops

**Library**

Dipl.-Bibl. Kerstin Hölscher  
 Phone: +49 2 08/85 98 -12 01  
 Fax: +49 2 08/85 98 -12 90  
 kerstin.hoelscher@umsicht.fraunhofer.de

Information management; literature and patent research

**Plastics Pilot Plant****Branch Willich**

Dipl.-Ing. Carmen Michels  
 Phone: +49 21 54/92 51 -14  
 Fax: +49 21 54/92 51 -61  
 carmen.michels@umsicht.fraunhofer.de

**Activated Carbon Pilot Plant****Branch Teterow**

Dipl.-Ing. Toralf Goetze  
 Phone: +49 39 96/1 59 -3 80  
 Fax: +49 39 96/1 59 -3 90  
 toralf.goetze@umsicht.fraunhofer.de

# Hot Market for Waste Grease

## In Dialogue with Dr.-Ing. Volker Heil

*1. You work on converting waste grease into bio-based diesel. Imagine you had to explain your research to your children Jonathan and Tabea.*

Imagine you are making french fries – not in an oven like at home – but in a restaurant with oil, and afterwards you want to do something useful with the waste grease. One option is to use the grease instead of gasoline as fuel for cars. That does not mean that you have to go to a restaurant instead of a gas station to fill your tank, but that one can take the grease and convert it to a fuel through a technical process. In order to do that you need very high temperatures up to 650 °C and very special materials especially activated carbon which is a black powder made from carbon. Six grams of it can have the surface area of an entire soccer field on the inside, and when you run the old grease over it in the right manner you eventually get fuel that can be used in cars. We cannot use this fuel in our car which has a gasoline engine, but it can be used in cars with diesel engines.

*2. How does your process differ from the widely used, conventional biodiesel production process?*

The main difference is that using the greasoline® process concept we produce traditional diesel just like you get at the pump now with one important difference: Our diesel is based on biomass and not on petroleum. I would like to emphasize here that biodiesel has a different structure than conventional diesel because they are often confused. Biodiesel is made up of long-chained hydrocarbons with a methyl ester group attached at the end. Diesel does not contain this group. It has advantages in

terms of environmental friendliness but also disadvantages in terms of availability to the engine. Assuming that an engine should be operated with standardized fuels, it is nice to have fuels that are identical to the ones produced from petroleum which is the case with diesel produced by greasoline®.

In addition, glycerin is generated as a byproduct of biodiesel production. The mass balance is roughly: 10 kg oil + 1 kg methanol yields 10 kg biodiesel + 1 kg glycerin. Once upgraded to pharmaceutical industry for the production of ointments for example. However, it will not be possible to utilize all the pharmaceutical glycerin that will become available on the market in the coming years. One large advantage of the greasoline® process concept is that no glycerin is generated. In parallel research, we are working on new applications for glycerin and to convert it to chemical raw materials such as propylene.

Last but not least, there is a large difference in the two processes with regard to the composition of the source materials. While biodiesel production in many cases only works well with strictly defined source materials such as canola, soy or peanut oil, our process is based on waste grease which can vary greatly in their composition. There is no strictly vegetarian waste grease. It will always contain a certain amount of animal fats and especially free fatty acids. These free fatty acids can be very problematic for some biodiesel production processes. They don't pose a problem for us. We can even use pure free fatty acids by themselves in our greasoline® process concept.

*3. Where do you get the waste grease from and how much of it is available in Germany?*

The developments in this area are quite interesting. When we started working on this topic, waste grease was a real disposal problem. This even applied to high quality frying oils which are accumulated at fast food chains in large amounts. 300 000 tons of this material, which is abbreviated "UFO" for Used Frying Oils among experts, are amassed in Germany each year. In Europe, that number is projected to be 3 million tons. In the meantime, the situation has changed. Many types of waste grease are being used today and officially traded on the market. The high-quality waste grease is highly sought after. The interesting aspect of our process is that we are confident that we will be able to use low-quality waste grease which is not clean enough that it only has to be filtered to be used as fuel.

*4. Please explain how the greasoline® process concept works.*

Initially, the grease has to be processed mechanically which means that dirt has to be removed. Then it is heated up to even be able to feed it into the reactor. At this point it is not clear yet whether to feed the grease into a gas stream or to heat it first. Nonetheless, it is important that we get the grease into the gas phase. Next the core process step follows in the form of activated carbon treatment most likely in a fixed bed reactor. The grease goes in and out come shorter and longer chained hydrocarbons that are separated. It is easiest to cool them and remove the liquid portion. Everything that remains in the gas phase such as materials without ca-





Dr.-Ing. Volker Heil (Grad. 1963)  
 Studied chemical engineering at the University of Dortmund.  
 Since finishing his PhD in which he worked on concentrating suspended solids through continuous sieve centrifuging processes, he has been working at Fraunhofer UMSICHT.  
 Dr. Heil's key competencies are in the areas of activated carbon development, sorption technology, and biofuels.  
 He is one of the inventors of the greasoline® process concept.

Dr. Heil is married and has two children.

lorific value, inert gases, and short-chained products is recirculated and used for heating the reactor. From recycling management view, this is the perfect process because the waste greases are not disposed of but are effectively processed for future use.

*5. When are you expecting the greasoline® process concept to be ready for market?*

The project is running until July 2007. At that point, a small pilot plant with a capacity of 5 liters of grease per hour will be running. After that, one could scale up to a demonstration plant. From now, we are expecting the process to be ready for market in about four years.

*6. We have learned much about your*

*professional activities. Now we would like to hear a little bit about your private side. Which book is currently on your nightstand?*

There are two. The first one is "Tintenblut" by Cornelia Funke. I read this book to my children. The fascinating book "On her Majesty's Wizardly Service" by Diane Duane helps me relax. The story of a group of magically talented cats plays in the time of Victorian England.

*7. Since I know that you love music, I don't want to close this interview without a music tip from you.*

Currently my favorite is Solo Para Ti by Ottmar Liebert and Luna Negra.

## R&D Services

---

infernum und TheoPrax®

Chemistry and Analytics

Biotechnological Laboratory

Marketing, Communication, Business Development

IT Management

Central Technical Facilities

Library



Successful research and development needs good service and proper management – external as well as internal! Therefore we provide the allround service our business units profit from to our customers as well.

## infernum

In collaboration with the FernUniversität (Open University) in Hagen, Fraunhofer UMSICHT has been offering an interdisciplinary distance learning program for environmental sciences since November 2000. The goal of the four-semester continuing education program is to provide up-to-date, practical, and comprehensive environmental know-how to students both in their own and related disciplines and is specifically designed for engineering, science as well as law and humanitarian students. This imparts the students with the interdisciplinary skills, which are necessary for solving complex environmental problems.

The accredited master degree infernum, entitled "Master of Environmental Sciences", has been met with widespread interest in Germany and even beyond its borders in countries such as Austria, Switzerland, the USA, China, and South Africa. The students have a broad spectrum of professional and personal backgrounds including engineers, various scientists, and other educational backgrounds as for instance business, medicine, theology, or education.

During workshops, the students get to know the teaching staff and fellow students while expanding on the obtained knowledge with technical lectures and

learning how to work in interdisciplinary teams.

The Hochschulgesellschaft Oberhausen e. V. regularly awards scholarships for infernum. The scholarship recipients are characterized by excellent scientific qualifications and a special personal or professional commitment to environmental protection and sustainable development.

The Fraunhofer-Gesellschaft chose infernum as one of three model projects for the recently founded Fraunhofer Technology Academy. The Technology Academy will commence in 2006 and convey innovative know-how to business executives.  
[www.technology-academy.de](http://www.technology-academy.de)

On November 14<sup>th</sup> 2005, infernum was awarded the title "Official project of the decade of the United Nations for the education of sustainable development 2005 – 2014" as part of an event at the Thüringer Landtag (Thuringian Parliament). The United Nations certified with this award that the infernum program helps make sustainable thinking and acting reality.



## TheoPrax®

The educational model TheoPrax® is a practical experience and systems oriented approach that aims to combine theory and practice early on. Initiated by the Fraunhofer Institute for Chemical Technology ICT (Pfinztal), TheoPrax® has been successfully applied in Baden-Württemberg since 1998. As part of a nation-wide expansion, a TheoPrax® communications center was established at Fraunhofer UMSICHT in order to introduce the educational model in the Rhine-Ruhr region.

### How does TheoPrax® work?

Firms contact Fraunhofer UMSICHT with industrial problems. Acting as the regional communication center, Fraunhofer UMSICHT then forwards the problems to schools and universities, where students form groups to solve the problems.

### What are the benefits of TheoPrax®?

TheoPrax® gives students an opportunity to get an early insight into the professional world, which helps them develop key skills such as creativity, conflict resolution, communication, and team work. Employers can recruit young talents that are aware of what it takes in business. They can also present their company's profile to the potential employees in the context of the project work. Therefore, TheoPrax® represents an ideal platform for the development and acquisition of the future workforce.

### Your contact

Dipl.-Ing. Anja Gerstenmeier  
(+49 2 08/85 98 -11 11)



# infernum/Theoprax®

## Chemistry and Analytics

Precise and reliable analytics are a precondition for the solution of environment-chemical questions. Scientists and technical staff work together in the highly qualified and experienced team "Chemistry and Analytics" to complete this task.

For this purpose, laboratories with an extensive instrumental equipment, among others state-of-the-art analytical system combinations, are available at the institute.

The wide spectrum of services offered particularly contains the development of innovative, custom-made methods, currently for example

- ultra trace analysis of pharmaceuticals and endocrine matters in wastewater,
- characterization of secondary fuels,
- plastics analysis and
- biocide determination in art treasures made from wood as well as
- measuring of siloxanes in landfill gases.

The validation of measurement results is carried out among others by comparison with external laboratories (inter-laboratory tests).

We further focus on the optimization of technical processes for qualitative improvement of products (ash, slag).

Our team offers analytical solutions, consulting services in the planning of examinations, and helps evaluating your analytical results.



# Chemistry and Analytics



# Biotechnological Laboratory

## Biotechnological Laboratory

The biotechnological laboratory handles tasks on the cleaning of polluted media (water, soil, air), examines biological decomposition and production potentials, and develops novel microbiological processes from laboratory to pilot plant scale.

New biotechnological processes and plants are planned step by step, designed and examined to ensure technological feasibility at a high level of efficiency and operational safety. The biotechnological laboratory can realize creative and efficient solutions by cooperating with engineers and natural scientists of the analytics and the engineering departments.

As an approved testing laboratory of "Bundesgütegemeinschaft Kompost e. V." (Federal association of compost quality standards), and approved testing laboratory of DIN CERTCO for testing of composting capability of materials according to DIN V 54900-1 to -3, ISO 13432, ASTM 6400 we offer:

- microbiological analyses according to DIN, ISO, OECD-processes
- testing of biodegradability under aerobic and anaerobic conditions (e.g.  $AT_4$  and  $GB_{21}$  according to "Abfallablagungsverordnung" [Regulations concerning waste disposal])
- Development of biotechnological production processes



# Marketing, Communication, Business Development

## Marketing, Communication, Business Development

The marketing of products and services, analyzing, and handling of business sectors, developing new market strategies, and finally representing the institute in public are the tasks of the department of "Marketing, Communication and Business Development". Being directly responsible to the directorate, we support the scientific staff in the positioning of new products and fields and in tailoring them to the customer's requirements. Market surveys and technology studies help to assess opportunities and risks of new developments at an early stage.

**Developing and preparing** the institute's public relation materials and web appearance is among our strengths. Our web news regularly and readily keep editors and journalists updated about the latest research results at Fraunhofer UMSICHT. To protect new developments from plagiarism, our department is also responsible for the registration of **inventions**, assistance in **intellectual property rights**, and in license agreements.

**Innovation management and marketing** are more than void phrases for us:

our services encompass guided brainstorming, market surveys, business sector analyses and strategies, market introduction of products, marketing concepts and industrial property rights policies as well as public relation concepts, particularly offered to small and medium-sized enterprises.

We want projects with Fraunhofer UMSICHT to be attractive, successful, and reliable projects – for our customers and together with our customers!

## IT Management

An efficient and reliable information and communication technology service is an indispensable prerequisite for any efficient project work. The IT management provides internal and external services, focusing on the following areas of expertise:

- planning, continuous operation and support of the DP infrastructure
- provision and update of software packages
- assistance in IT-specific problems

A powerful and available network enables the effective utilization of the IT services. In addition to redundant file servers that include capacities in the terabyte range with adequate data security, an increasingly important intranet is at our disposal.

As part of the Fraunhofer internal project Competence Center Application Service Providing (<http://cc-asp.fraunhofer.de>), technical and economic support for the implementation and operation of Server Based Computing is offered to Fraunhofer institutes.

The LANrunner® ([www.lanrunner.de](http://www.lanrunner.de)) system is a solution developed by the IT management for effective network analysis, reporting, and long-term statistics which enables the optimization of a network and, accordingly, an entire IT infrastructure.

The IT management supports apprenticeships for computer scientists with a concentration in system integration.



# IT Management

# Central Technical Services



## Central Technical Services

The cycle times of technological innovations are minimizing rapidly in industrial and process engineering.

In order to secure a technological head-start and not only keep pace with others, a smooth and prompt realization must be guaranteed.

The central technical facilities realize technological know-how for internal and external customers quickly and competently.

Specialized on the sector of test, pilot and demonstration plants our strengths lie in:

- basic and detail engineering
- implementation of process control systems and
- measurement, control technology and control engineering.

Technical service is the basis of our work. Our team, consisting of electricians, mechanics and engineers, accompanies you the whole way: starting with the consultation, over planning and construction to the final production of your plant, we try to find the best solutions together with you.

Among other things our repertoire comprises the made-to-order production of special components and the production of ready-to-operate technical plants.

We invest in the future by handing our know-how down to the succeeding generation. Trainees in different fields set out on their way into the future in our facilities.



## Library – Specialist Information Service

“Knowledge” has long since become an economic factor securing technological advantages of a location. For keeping the scientific-technical qualification of our staff always highly up to date, the scientific specialist library provides literature on the UMSICHT-specific topics environment, energy, safety, and process technology as well as know-how and technology transfer.

At present our stock comprehends approximately

- 7 050 monographs
- 43 subscriptions to scientific journals
- 27 permanently updated loose-leaf-collections
- 11 information services (among others publication series of ministries organizations, and institutions)
- bulletins issued by government boards in various research disciplines

### The Library

- supports scientific personnel in obtaining specialist information in the Internet via an own Intranet-homepage serving as specialist portal,
- carries out literature and patent researches,
- trains staff in researching in end user services provided,
- documents own publications for the world wide accessible database Fraunhofer Publica and
- is in charge of UMSICHT publications (conference transcripts, dissertations etc.) from advisory support the author to the delivery of the printed copy to the “Technische Informationsbibliothek” (TIB, Technical Information Library) in Hanover.



# Library

“An enormous reservoir of natural raw materials grows every day. Let the diversity inspire us to think of and develop new products beyond crude oil.”

[Dr.-Ing. Stephan Kabasci, Business Unit Manager Renewable Resources]



We develop and optimize technological processes for the extraction of valuable substances and the generation of energy from renewable resources and residues. Our strengths lie in the application of biotechnological processes and in plastics technology.



The Institute

## Business Unit Renewable Resources

---

Modeling of Enzyme Catalyzed Processes  
Succinic acid – Basis of Future Biorefineries  
Material Development for the Plastics Industry  
Service Spectrum for Biogas Technology

Business Unit Process Technology

Business Unit Waste Management/-Technology and Adsorption

Business Unit Advanced Materials

Business Unit Safety Engineering

Business Unit Energy Technology

Business Unit Energy Systems

Business Unit Know-how and Technology Transfer

Names, Data, Events



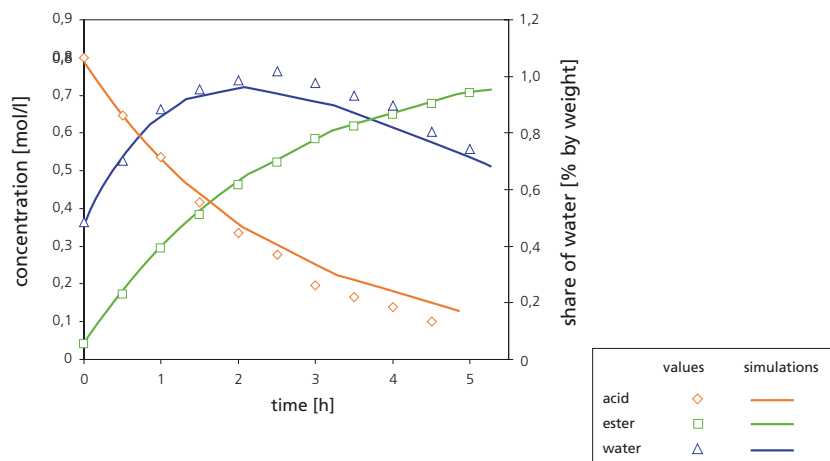

Pervaporation-supported enzyme catalyzed esterification (comparison of simulation and experiment at a temperature of 50 °C)

### Modeling of Enzyme Catalyzed Processes

Biotechnological processes such as enzymatic catalysis are becoming increasingly prevalent in industrial production. Research priorities are directed towards the development of environmentally friendly and economically viable processes. System modeling serves as the basis for optimized process design and helps to move towards these goals.

The esterification of alcohol with organic acids is a widely used reaction in which lipases serve as enzymatic catalysts. The produced esters can be used as natural flavorings and fragrances. Using the example of the synthesis of isoamyl acetate, one of the main components of banana aroma, a pervaporation-supported process was developed and modeled. Pervaporation is a membrane process in which a vacuum generates the driving force for separation.

Thus, the water being produced during the esterification can be improving the product formation of the balance reaction.

The basis for the mathematical description of the process was laid using experimental results from enzymatic catalysis, pervaporation, and the combined process. The reaction simulation is based on fundamental enzyme kinetics. An empirical equation was derived for the water separation via the cmc-vp-31 membrane. The equation describes the flow through the membrane in dependence on the essential influencing variables such as temperature, composition of the feed solution, and permeate pressure. The Aspen Custom Modeler (ACM) software was chosen as the simulation environment. The pervaporation model previously developed at the University of Dortmund, Department of Thermal Process Engineering, was utilized and adapted to the needs of the project.

The aggregate model available now is a tool for process analysis that can easily be transferred to similar reactions due to its modular structure.

#### Your contact

Dipl.-Ing. Ulrike Ehrenstein  
(+49 2 08/85 98 -11 56)  
Dr.-Ing. Stephan Kabasci  
(+49 2 08/85 98 -11 64)

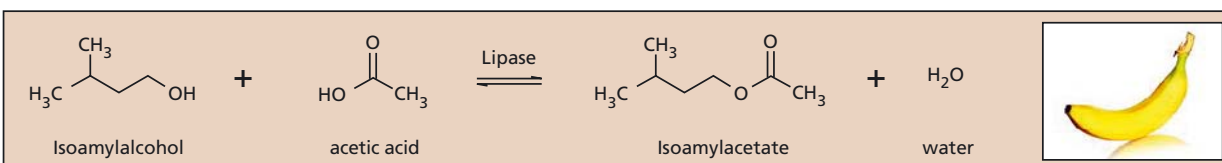

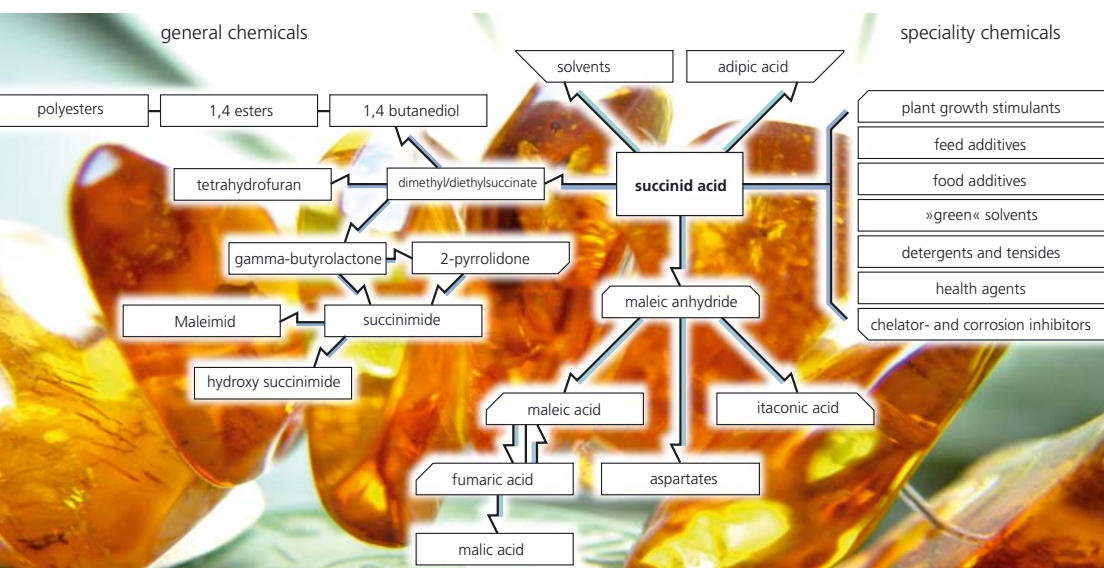

Many production paths lead from succinic acid as shown by the product family tree.

## Succinic Acid – Basis of Future Biorefineries

In biorefineries, bio- and thermochemical processes can be employed to convert renewable resources into chemicals, materials, and fuels. Fraunhofer UMSICHT is focusing on succinic acid ( $\text{HOOC-CH}_2\text{-CH}_2\text{-COOH}$ ), a dicarboxylic acid that is used in the food industry among others. Succinic acid appears to be a promising platform chemical as the basis for a biorefinery because it can be produced from renewable resources and it can be used as a  $\text{C}_4$  building block for the synthesis of bulk chemicals (e.g. 1,4 Butanediol), specialty chemicals (e.g. itaconic acid) as well as high-priced specialty materials (e.g. polyamides, and polyesters), and environmentally friendly solvents.

Using petrochemical feedstock, succinic acid is conventionally generated from maleic anhydride in a two stage process. For the aroma industry, it is already produced biochemically in small amounts and with high purity via fermentation from glucose. Currently, petrochemical synthesis is lower in production cost, but Fraunhofer UMSICHT is working on reducing the costs of fermentation. Two bacteria strains were tested to determine whether they perform well using minimally treated starch based on corn, potato, or wheat.

The bacterium *Anaerobiospirillum succiniciproducens* turned out to be very favorable: Inexpensive starch is sufficient for it as a carbon source for the succinate synthesis. The highest succinic acid yield was accomplished

using corn starch and was comparable with the results from pure glucose fermentation.

The succinic acid produced via fermentation and its derivatives were used as input materials for the synthesis of polyamide 44. Polyamide 44 was analyzed using IR spectroscopy, and the melting point was determined to be  $329\text{ }^\circ\text{C}$  which is extremely high. Previously, only crystallographic and magnetic nuclear resonance data were available in the literature for this polyamide.

### Your contact

Dr. rer. nat. Rodion Kopitzky  
(+49 2 08/85 98 -12 67)

Dr. rer. nat. Ute Merrettig-Bruns  
(+49 2 08/85 98 -12 29)

Innovative biodegradable plastic formulas have to prove their processability on conventional injection molding machines.



### Material Development for the Plastics Industry

Polymeric materials have become an integral part of our lives. Whether in the form of packaging, car parts, or CDs, we encounter the long-chained molecules on a daily basis because they combine exquisite mechanical characteristics, good processability, and an outstanding cost/performance ratio. In 2003, every European citizen used approximately 98 kg of plastic, and the amount is steadily increasing. However, every success story has its catch: The majority of plastic materials is based on petroleum, which is getting more scarce and expensive. Therefore, alternatives are needed urgently.

Based on this challenge, Fraunhofer UMSICHT is focusing on renewable resources for the systematic development of new plastics and the tailored design of resource-conserving materials such as wood fiber reinforced compounds and recycled plastics. The goal is to adapt the product characteristics to the needs of the customer.

#### Our testing capabilities

Density, bulk density, melting index, residual moisture, interior moisture, ash content, tensile strength, impact strength, notched impact strength, bending characteristics, shore hardness, grading or particle size distribution, DSC, FT-IR, pyrolysis GC-MS, Vicat-softening temperature, indentation hardness, puncture impact behavior, viscosity measurement, thermal conductivity, forward resistance, surface resistance, dielectricity relative permittivity, production of samples, testing of compostability according to DIN V 54900-1 up to -3, DIN EN 13432, and ASTM D 6400, extensive chemical and biological analyses

In our plastics technology laboratory, compounds are produced using the hot/cold mixer and rolling mill. The samples are then processed into semi-finished products via laboratory press, small scale extruder, or the blown film plant. Aside from the material characteristics, our developers are dedicated to aim for perfect processability. All materials from Fraunhofer UMSICHT can be used in conventional plastics machinery without extensive modifications.

All blends and compounds can be produced in pilot and small series at the extrusion laboratory on single and double screw extruders. The processability is tested on large scale production samples.

At the injection molding laboratory, two injection molding machines with various shot weights are installed to make injection molding pieces. Flexible fabrication of small series and prototypes is possible without the need for the contractors to disrupt their production processes.

The extensive testing capabilities regarding thermal, mechanical, and electrical characteristics enable constant examination of new materials and customers' samples.

One of the latest developments is a new foil compound. The material is comparable to HDPE<sup>1</sup> with regard to mechanical and haptic characteristics but is primarily made from polylactic acid. This high-quality foil is semi glossy with high transparency.

#### Your contact

Dipl.-Ing. Carmen Michels  
(+49 2 08/85 98 -12 65)  
Dipl.-Ing. Thomas Eisenburger  
(+49 21 54/92 51 -27)

<sup>1</sup> HDPE = High Density Polyethylene

## Service Spectrum Biogas Technology

The primary goals of sustainable development are the reduction of environmental pollution and the conservation of fossil resources. One step towards the realization of these goals is the utilization of renewable resources for the generation of energy in biogas plants. In the field of biogas technology, Fraunhofer UMSICHT offers a broad spectrum of research and development services.

The R&D-portfolio encompasses

- biomass potential evaluation and development of integrated concepts for biogas generation from renewable resources and organic residues,
- market and feasibility studies, expert reports on economic and technologic assessments of biogas plants,
- consulting, analysis, and planning of integrated utilization concepts for biogas (electricity, heat, cold, natural gas grid feed),
- assistance with permitting of innovative plant concepts,
- planning and construction of laboratory and pilot scale plants, and
- consulting and assistance with scale-up of new technologies.

Fraunhofer UMSICHT passes its extensive experience in the field of biogas plant technology along to its customers by assisting with the development of biogas projects and the improvement of the economic viability of biogas plants.

We offer a comprehensive set of process and product testing services at our in-house laboratory which was approved for investigations of digestion products and compost by the Bundesgütegemeinschaft Kompost (Federal association of compost quality standards).

### Your contact

Dipl.-Ing. Joachim Krassowski

(+49 2 08/85 98 -11 62)

Dr. rer. nat. Ute Merrettig-Bruns

(+49 2 08/85 98 -12 29)

### Services of the laboratory

- Investigations regarding the microbial degradation under aerobic and anaerobic conditions (e.g. AT4 and GB21 according to the waste storage regulation)
- Execution of tests for the anaerobic digestion of organic materials according to VDI 4630
- Microbiological analyses according to DIN, ISO, OECD-processes
- Continuous digestion tests in online-monitored laboratory bioreactors
- Analyses of feed materials with regard to heavy metal content, nutrient content, and gas formation rate for example



Biogas plant Schloss Wissen – View on the collection pond, buffer tank, and digester



Heated by bioenergy: Schloss Wissen in Weeze – always worth a trip

“Process technology means to view the process chain as a whole. Modeling, simulation, and demonstration plants are our tools. That is how theory is turned into tangible practice.”

[Dr.-Ing. Görgo Deerberg, Business Unit Manager Process Technology]



We develop and realize system solutions for process technology based on demonstration plants in the laboratory or workshop as well as on model-based simulation software. Our strengths lie in the membrane, high pressure, and reactor technology.





The Institute

Business Unit Renewable Resources

## Business Unit Process Technology

---

Optimization of Bubble Column Reactors

Technology with Holes: Microsieves for Filtration  
Technology Applications

Impregnation of Wood with Supercritical  
Carbon Dioxide

Naturally Healthy Thanks to Membrane Technology

Business Unit Waste Management/-Technology and Adsorption

Business Unit Advanced Materials

Business Unit Safety Engineering

Business Unit Energy Technology

Business Unit Energy Systems

Business Unit Know-how and Technology Transfer

Names, Data, Events

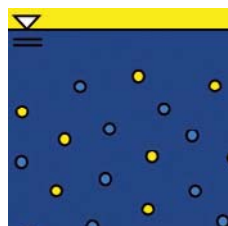

### Optimization of Bubble Column Reactors

Gaseous and liquid substances are often brought into contact in bubble column reactors in order to facilitate mass transfer between the involved phases. Many products from the chemical industry are produced in this manner. The interest to improve this type of reactor is accordingly large.

Reactions such as chlorination often take place in two or three phase reactors with heat evolution (or toning) in bubble column reactors. As part of an industrial contract, a process for the chlorination of an organic substance with high safety and material requirements was analysed and optimized.

The goal of the research was to increase the selectivity of the reaction which leads to an economic advantage for the entire process. Often, reducing back-mixing in the liquid in the reactor increases the selectivity. The effects of various technical options for the reduction of back-mixing can be simulated using the computer program »WinBSR«, which was developed by Fraunhofer UMSICHT specifically for the simulation of bubble column reactors. The development of the optimization recommendation can be classified into three phases:

1. formulation of a validated simulation model,
2. execution of variation calculations to evaluate suitable technical modifications,
3. experimental validation of the derived optimization recommendations.

The first phase is completed in close collaboration with the operator of the bubble column reactor. Data and operational experience are gathered and used for developing a validated model. Missing data can be filled in by the expert knowledge stored in the program.

The simulation of technically suitable reactor modifications follows based on a validated model. Possible modifications could be, for example, sieve plates or packings. Finally, it is important to experimentally test the theoretically derived measures with regard to their effectiveness.

#### Your contact

Dr.-Ing. Jürgen Grän-Heedfeld  
(+49 2 08/85 98 -12 74)

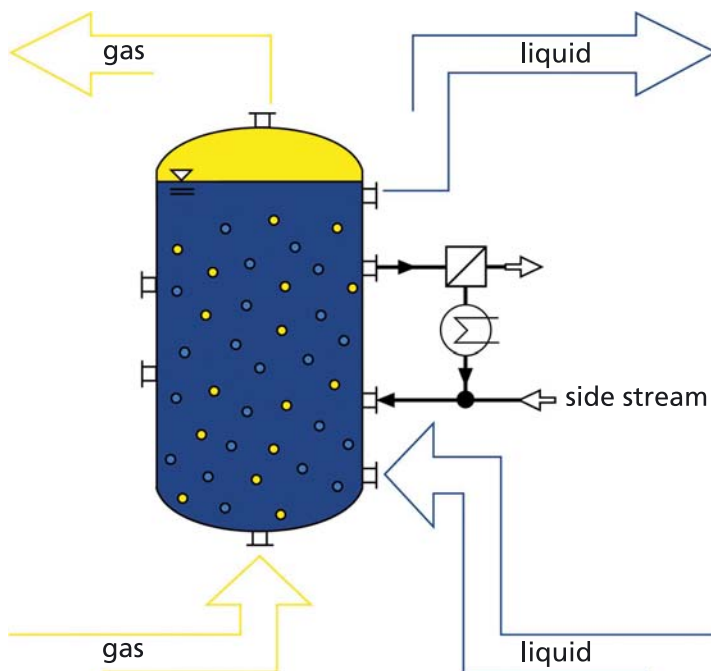

The gaseous substances are fed at the bottom of the usually circular bubble column and rise in the form of bubbles through the liquid phase. The schematic shows the topology of a bubble column reactor simulated with the »WinBSR« program.

## Technology with Holes: Microsieves for Filtration Technology Applications

Wastewater treatment and the production of sterilized drinking water and hygienically satisfactory food are central tasks of process technology. Modern micro structuring techniques are opening new doors because, based on new production and molding processes as well as laser technologies, high quality shapes and geometric structures with dimensions in the micrometer range ( $0.1 \mu\text{m} - 1000 \mu\text{m}$ )<sup>1</sup> can be produced at comparably low costs.

Fraunhofer UMSICHT is taking advantage of these new methods to develop microsieves for water, wastewater, and food processing technologies. The microsieves exhibit well-defined pore structures ( $10 \text{ billion pores/m}^2$ ,  $d = 1 \mu\text{m}$ ) and extremely high filtration capacities.

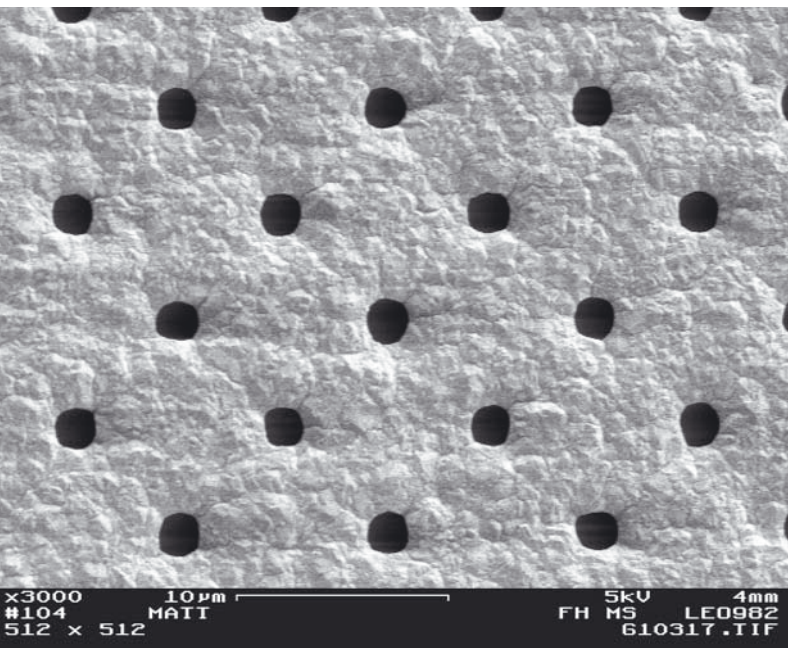

This is what a microsieve with a pore diameter of  $1 \mu\text{m}$  looks like in a surface electron microscope. On an area of  $1 \text{ m}^2$ , there are approximately 10 billion pores on a microsieve.

They, therefore, represent a new generation of “high flux” microfilters.

The characterization of the microsieves is accomplished via laboratory analysis (tensile stress test, confocal microscopy) and experimentation (permeation tests). In order to minimize fouling, oscillation-based filtration systems are employed.

Using a new, on-the-fly laser perforation process it was possible to fabricate large-area, robust stainless steel microsieves for pre-filtration with isopores of  $> 10 \mu\text{m}$ . For the actual product separation, microsieves in CD-size were manufactured based on micro molding processes. The homogeneous microstructure in combination with the minimal thickness makes the microsieves highly selective and gives them a filtration capacity of at least ten times that of conventional filters.

The microsieves are currently being tested in preliminary investigations in the brewery industry for the filtration of beer. The results showed that the permeate capacity stabilized around  $1.2 \text{ m}^3/\text{h}$  without any special antifouling measures.

At the moment, approaches for modeling the filtration behavior are being modified.

### Your contact

Dipl.-Ing. Ilka Gehrke  
(+49 2 08/85 98 -12 60)

<sup>1</sup> One micrometer equals one millionth of a meter.  $1 \mu\text{m} = 10^{-6} \text{ m}$ . The diameter of a human hair is approximately  $10 \mu\text{m}$ .

# Impregnation of Wood with Supercritical Carbon Dioxide

## Impregnation of Wood with Supercritical Carbon Dioxide

Wood, one of the oldest materials, is gaining new popularity especially in the construction and furniture industries due to increased environmental consciousness. Its easy workability combined with the low energy demand for harvesting and processing are the reasons behind that as well as its outstanding dampening characteristics. Users of wood value a long lifecycle and ease of recycling. Therefore, imported wood from Scandinavia, for example, is preferred because it meets quality requirements such as water absorption, dimensional stability, longevity, resistance to insecticides and microbial attack, and flame resistance.

In order to improve the economic standing of German forest enterprises, measures have to be taken to open new markets for local wood. On this basis, Fraunhofer UMSICHT is working on projects with the Ruhr University Bochum, Chair of Process Technology and the Institute for Wood Biology and Wood Technology of the University of Goettingen with the goal of optimizing the quality of native woods (beech, pine, and spruce) and of opening new fields of application to them.

One option to reduce the water absorption of wood and, as a result, to increase its longevity and dimensional stability is, for example, to integrate water resistant substances such as silicone and nanosole into the cell walls. Since the wood has to be penetrated completely, vacuum and boiler pressure processes lead to better results than conventional treatment methods such as painting, spraying, or submerging.

However, they are often still not sufficient despite being associated with extensive time and cost requirements.

Supercritical fluids<sup>1</sup> can offer new solutions for wood modification. Their capability to dissolve substances combined with excellent diffusion makes it an environmentally friendly solvent alternative. They have already proven their suitable characteristics for the impregnation of activated carbon, polymers, and cellulosic objects. Fraunhofer UMSICHT is currently investigating whether supercritical carbon dioxide is a suitable solvent for impregnation

treatments in heterogeneous matrices such as wood and insulation materials and how their characteristics can be influenced positively.

### Your contact

Dr. rer. nat. Joachim Danzig  
(+49 2 08/85 98 -11 45)  
Dipl.-Ing. Erich Jelen  
(+49 2 08/85 98 -12 77)

<sup>1</sup>At specific pressures and temperatures, every substance can be put into a supercritical state in which the characteristics of liquids and gases combine. Carbon dioxide reaches a supercritical state at 73 bar and 31.5 °C for example.



Nice to look at and thanks to supercritical fluids soon also easy to impregnate: Wood and insulation materials in the construction industry.

**Naturally Healthy Thanks to Membrane Technology**

Element systems of natural origin are tremendously complex. Coffee, a favorite drink of Germans, contains over 800 different substances and additional ones are constantly being discovered. A similar case is the immune system strengthening milk which, in addition to lipids, protein, carbohydrates, and minerals, contains a multitude of constituent types. It is hardly surprising that their effects on the human body are still unclear with such multilayered food structures. As a consumer, we judge the value of food based on taste and our well being after its consumption. These attributes are increasingly becoming the focal points in the development of new foods.

The new trend is to treat food as naturally as possible and to selectively reintroduce ingredients that have known, beneficial health effects. For example, green tea contains a polyphenol that reduces intestinal food uptake and increases fat burning; omega-6 fatty acids in vegetable from maize, and thistle oils protect the cardiovascular system; and American researchers isolated the polyphenol resveratrol which might protect from Alzheimer disease.

In collaboration with businesses from the food industry, Fraunhofer UMSICHT develops processes with which to make food with better taste and dietary characteristics available.

Based on membrane, microsieve, and

crystallization technology, active and flavoring ingredients are extracted and specifically added to new products.

Two parts of peptide and one part of yogurt form the matrix for one such product which was developed with a family-owned business from the Crimea. The inhabitants of the peninsula in the northern black sea swear by the beneficial effects of green algae. The algae are often used at health resorts for the reduction of cholesterol, and the improvement of health issues related to bronchial illnesses. Since recently, the resort guests are spooning up the green remedy in concentrated form as an algae yogurt. The local producer makes up 5 tons per hour. Other product and project ideas are currently being worked on.

**Your contact**

Dipl.-Ing. Josef Robert  
(+49 2 08/85 98 -11 50)



Pretty green and pretty healthy: Algae yogurt from the Crimea helps stay healthy in natural ways.



“To think in loops is easy. To realize loops is much more challenging. Feasible material flow management protects the future in the long run.”

[Dr. rer. nat. Kai Keldenich, Business Unit Manager Waste Management/-Technology and Adsorption]



We manage material flows, develop sorption technology concepts for the cleaning and upgrading of gas and offer concepts for the incineration and treatment of heterogeneous material flows in the field of disposal technology.



The Institute

Business Unit Renewable Resources

Business Unit Process Technology

## Business Unit Waste Management/ -Technology and Adsorption

---

Energetic Utilization of Refuse Derived Fuels and Waste

Characterization of the Combustion Attributes of Refuse Derived Fuels (RDF)

BioRegio: Strategies for the Sustainable Energetic Utilization of Biomass

The greasoline® Process concept: Production of Biogenous Fuels from Waste Grease

Business Unit Advanced Materials

Business Unit Safety Engineering

Business Unit Energy Technology

Business Unit Energy Systems

Business Unit Know-how and Technology Transfer

Names, Data, Events



## Energetic Utilization of Refuse Derived Fuels and Waste

In 2005, the situation in German waste management changed with the implementation of the TA Siedlungsabfall (Technical guidance for residential waste). Prior to 01.06.2005, many types of waste were still being landfilled without treatment. This is not possible anymore under the Abfallablagungsverordnung (AbfAbIV); (Waste Storage Regulation). Preceding the ban on landfilling, alternative means of disposal that have arisen are, among others, the processing of mixed commercial and residential waste to produce refuse derived fuels (RDF) and the energetic utilization of high to medium calorific waste in mono incinerators.

### Refuse Derived Fuels

The discussions about existing capacities for RDF have mostly been about quantities rather than quality. In this area, the requirements of the cement or power industry are not always met. In addition, current capacities are not available in sufficient or expected quantities. Fraunhofer UMSICHT is currently conducting research on the qualitative improvement of RDF with regard to material handling when used with different firing technologies (e.g. size reduction for dust firing). In this manner, parameters such as ignition timing and combustion behavior can be influenced.

### MARS®

Using the MARS®-plant (modular incineration plant with reduced flue gas cleaning residues), tests for a stepped

combustion of high-calorific wastes such as commercial waste or various types of biomass were conducted. The process flow diagram shows the plant after an expansion for energy extraction via a thermal oil boiler. In addition, the fabric filter has been exchanged so that various investigations of additives for flue gas cleaning are possible.

### Your contact

Dr. Kai Keldenich  
(+49 2 08/85 98 -11 67)  
Dipl.-Ing. Asja Mrotzek  
(+49 2 08/85 98 -11 54)  
Dipl.-Ing. Ralf Bertling  
(+49 2 08/85 98 -14 08)

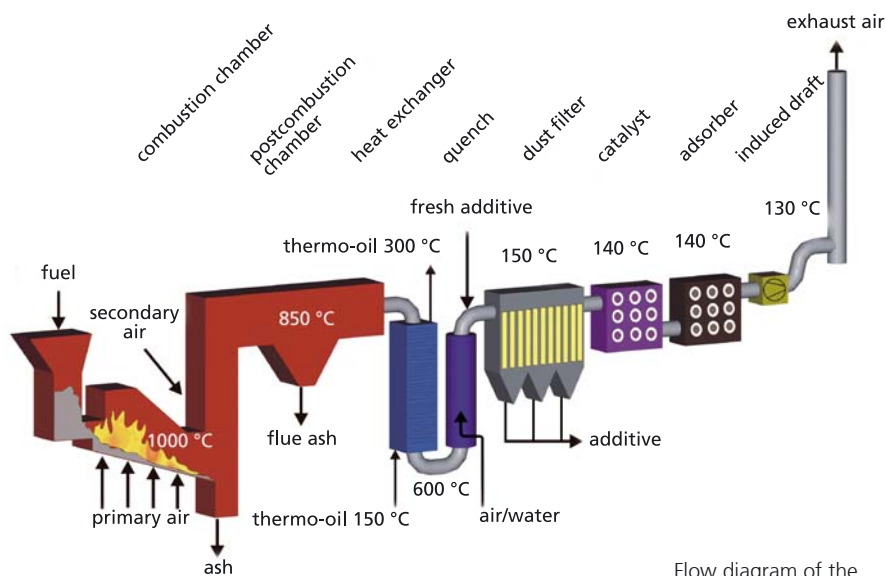

Flow diagram of the MARS®-plant



Fire



Refuse derived fuels



MARS®-plant



## Characterization of the Combustion Attributes of Refuse Derived Fuels (RDF)

The energetic utilization of renewable resources and refuse derived fuels<sup>1</sup> has been gaining importance in the field of combustion technology. While the combustion behavior of conventional energy carriers such as coal, oil, and natural gas has been extensively researched, there are still large uncertainties about the determination of the combustion behavior of refuse derived fuels due to the large variations in their composition. Common characterization methods are inadequate for the evaluation of these fuels because they do not give us any information on the temperature dependent release of volatile matter and their calorific value.

On this basis, the business unit waste management and the analytical laboratory developed a method for technical combustion characterization and the evaluation of different fuels. The measurement method delivers a temperature dependent release profile for each volatile matter released from the fuel. Similar to a fingerprint, the firing behavior of a fuel can be individually described in this manner. The determined parameters include traditional ones for fuel such as ash content, volatile matter, fixed carbon dioxide ( $C_{fix}$ ), elemental composition, and total calorific value, as well as more detailed parameters such as type, amount and calorific value ( $H_U$  and  $H_L$ ) of the volatile matter released at different temperatures. Using these data, the release of volatile matter for a specific combustion process, for example grate combustion, can be described.

The characterization of different fuels will be required in the future, as will be the advancement of the methodologies for the capture of chlorine and sulfur compounds. In the medium term, experimental data will be coupled with a firing and combustion chamber model in which the temperature distribution on a grate is iteratively linked to the calorific value of the fuel.

The developed analytical method offers great potential for the reduction of costs of large-scale tests and the guarantee of quality requirements of substitute fuels because the attained data form the basis for optimized plant design and the correct selection and production of refuse derived fuels. Simultaneously, they allow the descrip-

tion of the combustion behavior of diverse fuels.

We would like to thank ef.Ruhr, the state of North Rhine-Westfalia as well as the European Fund for Regional Development (EFRE) for the financial support of this project.

### Your contact

Dr. rer. nat. Thomas Marzi  
Telefon (+49 2 08/85 98 -12 30)

<sup>1</sup> Household and commercial waste fractions containing high calorific values made up of recycled resources but also production specific industrial waste are processed into refuse derived fuels (RDF) for energetic utilization.

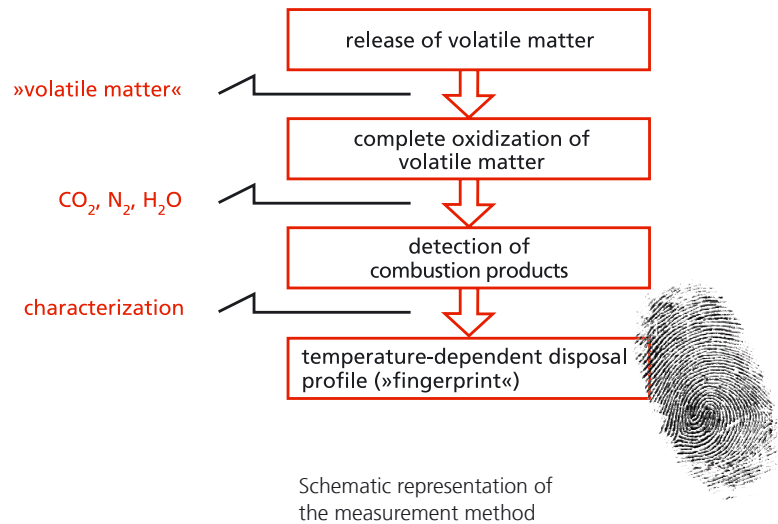

## BioRegio: Strategies for the Sustainable Energy Use of Biomass

Renewable resources create jobs and economic growth on a local level. Their generation and utilization promote climatic and environmental protection as well as safer energy supply. People informing themselves about sustainable energy supply will see these statements repeatedly. The German government's goal is to cover 20% of the electricity and 10% of the primary energy demand from renewable energy such as wind power, solar power, biomass by 2020, etc. But how much biomass is available to meet the needs of the present generation without compromising the ability of the future generations to meet their own needs?

There are big regional differences regarding the sustainable use of biomass in Germany. As part of the BioRegio project, entitled "Strategies for the sustainable energy use of biomass" and co-ordinated by the Institute for Future Energy Systems (IZES), these potentials are being analyzed. Between December 2004 and November 2006, the regional research partners, representing six chosen model regions in Germany, are investigating innovative bioenergy technologies and are determining biomass potentials on a regional basis. In addition, regional synergies and employment effects, which would be created through increased biomass utilization in the model regions<sup>1</sup>, are being evaluated. One of the main project goals is to assure the transfer of the results to other regions in Germany.



Fraunhofer UMSICHT is investigating the biomass potential in the Emscher-Lippe-Region, which is made up of the district of Recklinghausen as well as the cities of Bottrop and Gelsenkirchen. Approximately 1 million people live in this region in an area of about 1 000 km<sup>2</sup>. Initially, a network of participants was set up in the region, and the potential biomass resources in the forestry, agricultural, and waste sectors were calculated with their support. The results showed that the Emscher-Lippe-Region, as opposed to the other model regions, had disproportionately high biomass amounts in the waste sector. This can be attributed to the high population density in the small area. Aside from the biomass amounts, potential users of the energy were also identified. In the next project phase, the optimal biomass allocation is modeled using scenario analyses, and appropriate technologies are investigated. Based on the results, specific projects in the biomass area should be initiated, supported, and implemented.

Additional information on the BioRegio project, which was funded by the Ministry for Environment, Natural Conservation, and Reactor Safety, can be found on the project web site at [www.bioregio.info](http://www.bioregio.info).

### Your contact

Dipl.-Wirt.-Ing., MSc Markus Hiebel  
(+49 2 08/85 98 -11 81)

- <sup>1</sup> 1. Nature park Saar-Hunsrück (Institut für angewandtes Stoffstrommanagement IfaS);
2. Southern Upper Rhine (Öko-Institut e. V.);
3. Emscher-Lippe-Region (Fraunhofer UMSICHT)
4. Northeast-Western Pomerania and
5. Middle Saxony (Institut für Energetik und Umwelt GmbH)
6. Kiel, Eckernförde, Rendsburg, Neumünster - K.E.R.N. (Öko-Institut e. V.)



## The greasoline® Process Concept: Production of Biogenous Fuels from Waste Grease

20 % of chemicals, materials, and fuels are to be produced in biorefineries from renewable resources by the year 2020.

In the context of the key research area "Bio Refinery", Fraunhofer UMSICHT is developing technologies for the industrial utilization of renewable resources. Current research efforts include material synthesis<sup>1</sup>, identification of platform chemicals and product pathways<sup>2</sup>, and efficient synthesis and production of biofuels. The overriding goal of the work is to create the technological basis for future biorefineries.

The greasoline® process concept<sup>3</sup>, developed and patented by Fraunhofer UMSICHT, enables the conversion of waste oil and grease to biogenous diesel which is very similar to its petroleum-based equivalent as well as the much discussed biomass-to-liquid fuels in chemical composition.



Three aspects set this "fuel from the second generation" apart from traditional biodiesel based on vegetable oil:

1. It does not contain methyl ester groups and can be used without engine modifications.
2. No glycerin is generated by the greasoline® process concept. Moreover: There are currently proposals to use glycerin, a biodiesel production byproduct flooding the market, as an alternative feedstock in biorefineries and convert it to a chemical raw material such as propylene.
3. The greasoline® process concept works with variable waste oil and grease mixtures. Mixed vegetable and animal grease containing free fatty acids can be very problematic for some biodiesel production processes. They do not pose a problem for us. We can even use free fatty acids by themselves in our greasoline® process concept.

The greasoline® process concept opens the possibility to utilize all the remaining usable components of biogenous grease and oil after the higher value fractions have been removed. Such a complete material utilization of renewable resources will contribute to making biorefineries competitive regarding quality and costs compared to well-established petrochemical technologies and product structures.

### Your contact

Dr.-Ing. Volker Heil  
(+49 2 08/85 98 -11 63)

<sup>1</sup> see page 34: Material Development for Plastics Technology

<sup>2</sup> see page 33: Succinic Acid – Basis for Future Biorefineries

<sup>3</sup> see annual report 2004; p. 45

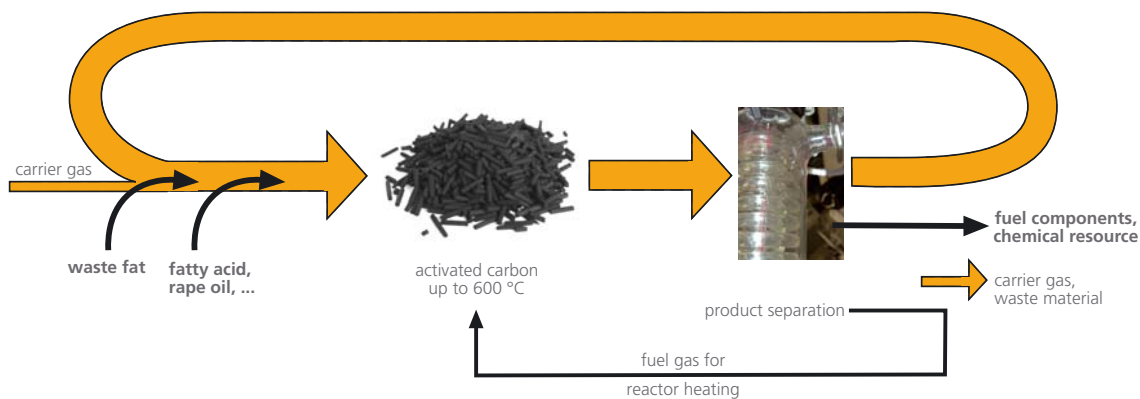

the greasoline® process concept



“There are 20 million known chemicals. Thus, material innovations do not emerge from new materials but by the smart combination and structuring of available materials. Our approach: We develop functional micro and nano particles in order to functionalize polymers!”

[Dipl.-Ing. Jürgen Bertling, Business Unit Manager Advanced Materials]

We are specialized in the design of high quality materials, which consist of several materials and are suitable for demanding applications. We are especially strong in combining material and process technological know-how.

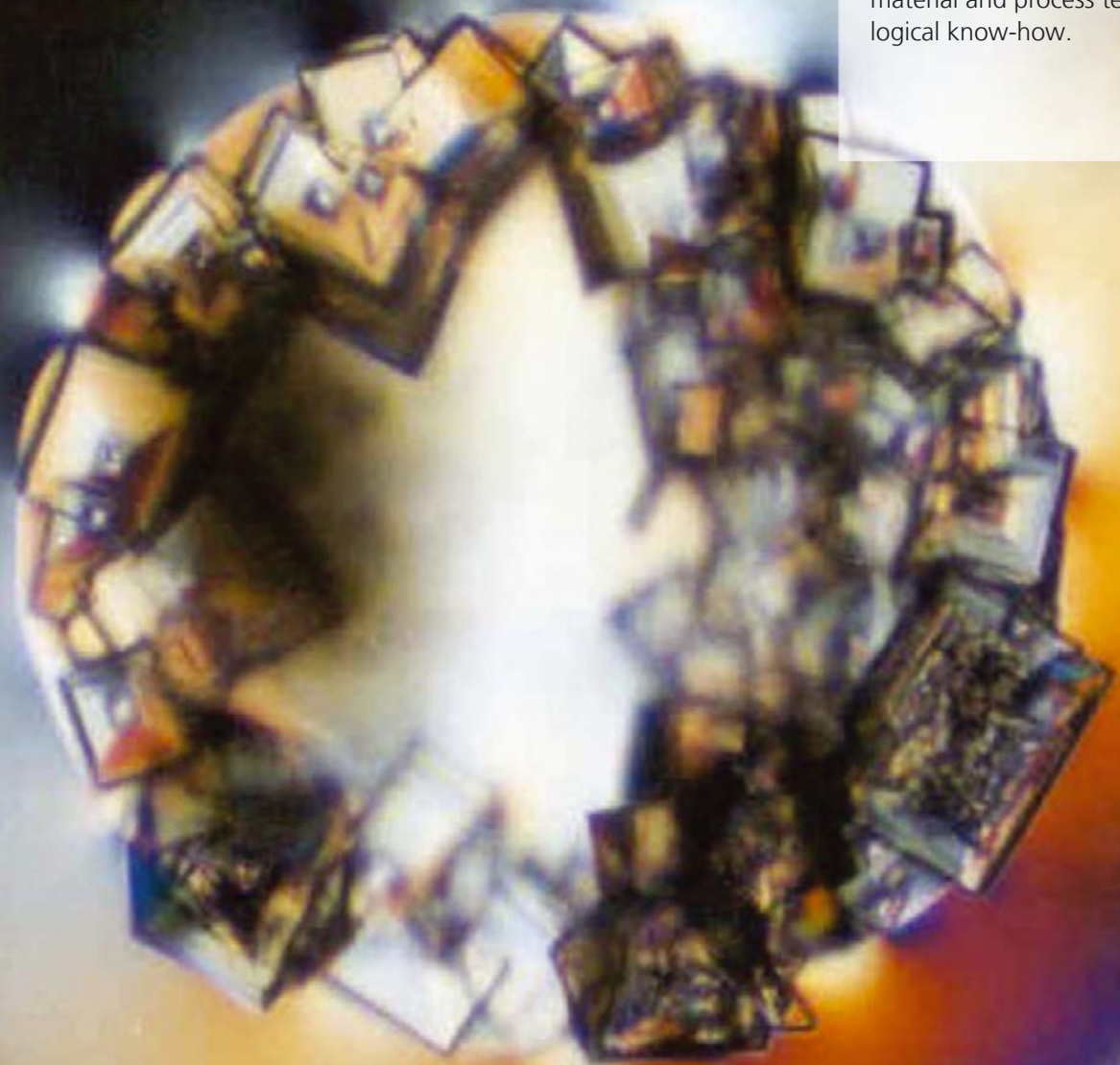

The Institute

Business Unit Renewable Resources

Business Unit Process Technology

Business Unit Waste Management/-Technology and Adsorption

## Business Unit Advanced Materials

---

Biomimetics as the Technology Vision of the Future?

Swellable Thermoplastic Elastomer Composites Q-TE-C®

System Analysis of Reacting Fluidized Beds

ParMa: Laboratory for the Parallel Synthesis of Particulate Materials

Business Unit Safety Engineering

Business Unit Energy Technology

Business Unit Energy Systems

Business Unit Know-how and Technology Transfer

Names, Data, Events

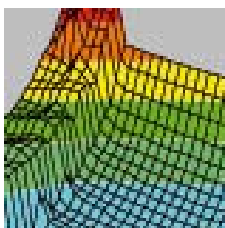

**Biomimetics as the Technology Vision of the Future?**

As part of a contract of the German Parliament (managed by the Office of Technology Assessment at the German Parliament – TAB), Fraunhofer UMSICHT developed a strategic report assessing the extent to which biomimetics can embody the technology vision of the future. The assessment focuses on current and future uses of biomimetic applications (national, international) and expands on the area of “biomimetics for new materials”.

The following pragmatic definition for biomimetics was developed: biomimetics is a variant of the innovation process in which the key component is an information transfer from biology to technology. Its goal is the development of a technological product or process on the basis of a biological model.

The basic understanding is pluralistic, inter- and multidisciplinary. The research principle is as follows: observe/discover, decode, transfer, and apply. Today, a large potential is in the fields of surface and fluid technology, construction, materials, and optimization. Future innovations are expected to be in the areas of sensors/actuators<sup>1</sup>, logistics, robotics, information and communication, organization, and management.

Historically, biomimetics initially went through a phenomenological-descriptive phase in which the observation and study of biologic models were at the forefront. Around 1950, model-based bionics (similitude theory) established itself in the areas of airplane, vehicle, and ship construction. Around 1960 (the term “bionics/biomimetics” was just born), biology and technology received a common linguistic and methodological basis through the influences of cybernetics: The gate for the knowledge transfer within biomimetics opened up.

Since the 90s, crosscutting technologies such as IT, nanotechnology, and mechatronics have been supporting the increasingly complex tasks faced in the field of biomimetics. The next phase in biomimetics will be shaped by the interaction of products and processes based on nature’s models with their surroundings.

Natural materials have adaptive abilities, multi-functionality, and resource-efficient structures. In order to utilize biomimetics for industrial material development, the interaction of function and structure of natural materials as well as the mechanisms for their generation, transformation, and self-healing have to be researched and understood better.

The research aspect of biomimetics positioning in Germany is positive. In the future, it will be important to pass on the knowledge of previous research efforts to the next biomimetics generation and also to chose research and development fields with selective strategies. The goal – and not the vision – should be to further integrate biomimetics and its research into the innovation process with shorter development cycles.

**Your contact**

Dr.-Ing. Hartmut Pflaum  
(+49 2 08/85 98 -11 71)  
Dipl.-Ing. Jürgen Bertling  
(+49 2 08/85 98 -11 68)

<sup>1</sup>Actuators = Branch of the control and automation technology

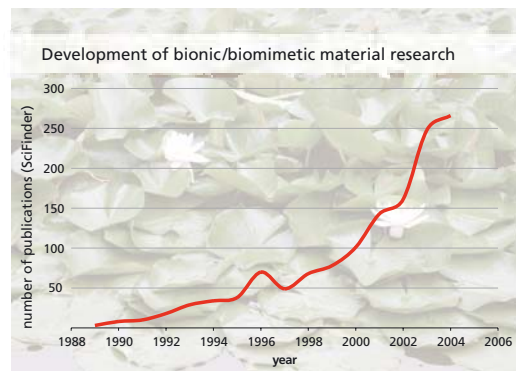

Biomimetic publications are increasing drastically

**Biomimetic search area**

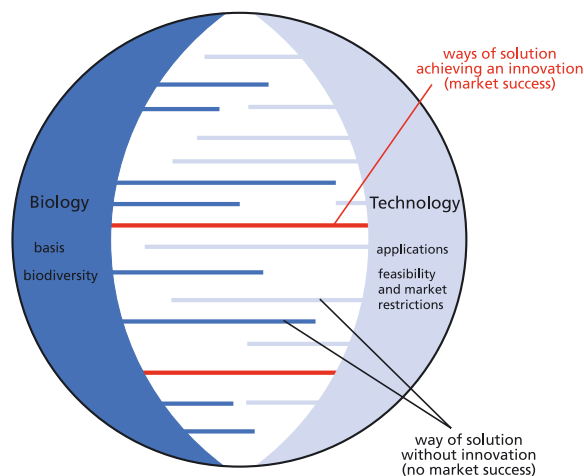

biomimetics require a controlled information transfer in order to lead to innovations

**New Material Basis:  
Swellable Thermoplastic Elastomer  
Composites Q-TE-C®**

Recently, swellable materials have been increasingly utilized especially in the areas of engineering and pipeline construction. They are used as seals in the area of in-situ cementing for sealing joints or wall/base connections for example.

Currently available products are costly because special raw materials (caoutchouc among other ingredients) have to be used to achieve high-grade material quality and the production processes based on rubber processing methods are elaborate. The substances added to achieve swellability make the production of films or shapes with complex geometrical structures difficult. Therefore, currently available products are primarily made and used with simple geometric profiles.

Products on the basis of a thermoplastic matrix have not been described yet. Through the combination of a thermoplastic matrix ground rubber and swellable acrylate polymers, Fraunhofer UMSICHT have developed a new material basis for the application in sealing technology. It can be produced with either rubber or thermoplastic characteristics and enables an economical product manufacturing and utilization (e. g. weldability) using thermoplastic processing methods.

As opposed to "classic" thermoplastic elastomer materials for which the elastomer is vulcanized during the compounding process, the thermoplastic

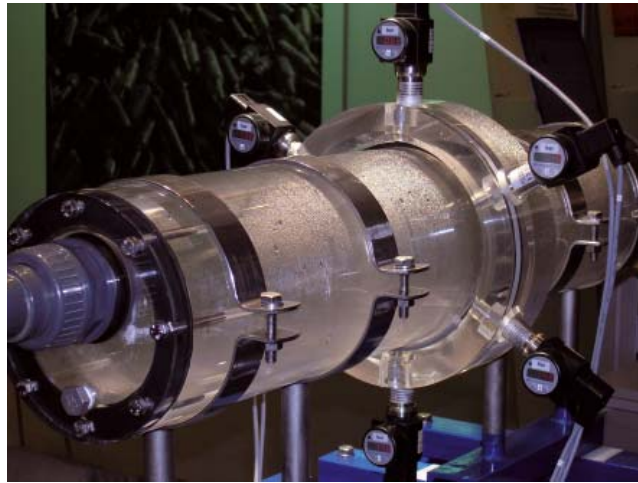

The seal in action: during experiments Q-TE-C® is displaying its self-healing abilities

elastomer composite production entails compounding of thermoplast with an already vulcanized elastomer powder. The swelling action of the Q-TE-C®-materials can be specifically adjusted dependent on the basic components that are used. Currently, the material is being optimized for use in the sealing industry and will be integrated into first products shortly.

The material development is focusing on the above mentioned industries. Additional applications are also expected to be in the utility, automotive, and installation industries.

**Your contact**

Dipl.-Ing. Holger Wack  
(+49 2 08/85 98 -11 21)

<sup>1</sup> TPE-V = Thermoplastic elastomer vulcanisates

<sup>2</sup> TPE-C = Thermoplastic elastomer composites

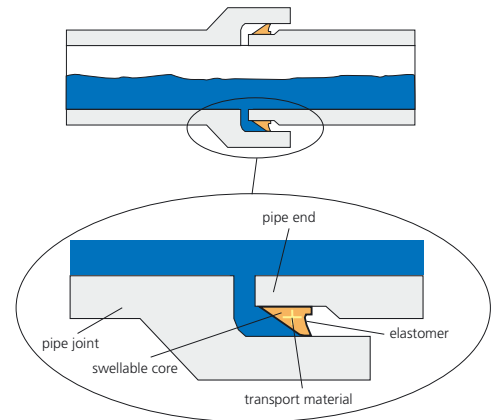

Self-repairing and controllable sewer pipe seal

### System Analysis of Reacting Fluidized Beds

Fluidized bed reactors are inseparably connected with a number of process technology applications. Fundamentally, they consist of a vertically arranged, cylindrical vessel which contains solid particles with an appropriate size distribution (powder > 50  $\mu\text{m}$ ). The particles are swirled by a gas coming through the vessel floor. Since the moving particles exhibit the characteristics of a fluid, the process is referred to as fluidization. Fluidized beds are very well suited for heterogeneous catalyses due to the high gas-to-solid exchange area. It is also a popular research subject based on the complexity resulting from numerous overlapping micro processes.

The goal of the BMBF-funded<sup>1</sup>, joint project is the development of a universally usable tool for the modeling, numerical simulation, and optimization of

fluidized bed processes with integrated chemical reaction.

The method is developed and tested on the basis of two example processes (gas phase synthesis of polyolefins and Müller-Rochow process as a pretreatment step for silicon production).

The main components of the modeling are the fluidization behavior of the frequently fine powders (A-type according to Geldart), the mechanisms and kinetics of the gas-gas and especially the gas-solid reactions.

Fraunhofer UMSICHT is developing a one-dimensional cell model that enables the description of the reactor condition including the particle size distribution along the vertical reactor axis. It makes systematic investigations and automatic optimization possible due to its high computation rate compared to detailed CFD-calculations. The focus is on the description of the chemical processes and the morphology of the particles. The fluidization is captured via simplified empirical correlations that are developed, fine-tuned, and optimized on the basis of new CFD processes for the calculation of the fluidized bed processes.

The figure shows an example of the volume portion of the emulsion and blow phase in a reactor during the synthesis of polyolefins.

#### Your contact

Dr.-Ing. Jan Blömer  
(+49 2 08/85 98 -14 06)

<sup>1</sup> The project with the funding number: 03X0500 LZ. 1.1.2005-31.12.2007 is completed by a consortium of research institutions and plant operators from the chemical industry. It is coordinated by Access e. V., Aachen and funded by the Federal Ministry of Education and Research (BMBF) as part of the "Material innovation for industry and society" initiative.

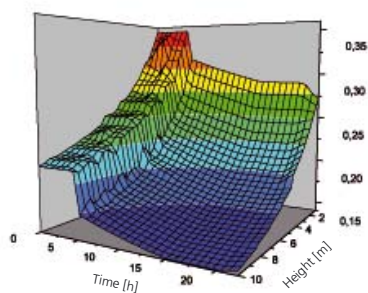

Time related changes of the blow portion in the fluidized bed with changing particle size distributions.

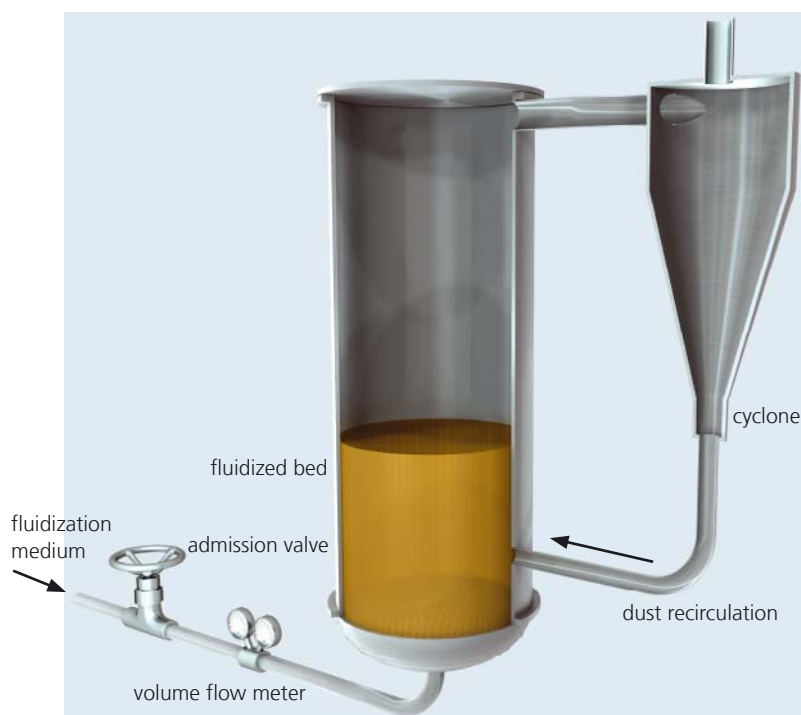

A fluidized bed is generated when the small-grained bed material is loosened by the upward streaming gas and, as a result, exhibits a liquid-like behavior.



## ParMa: Laboratory for the Parallel Synthesis of Particulate Materials

The development cycles of new products are getting shorter all the time. Simultaneously, the demands for functionality and quality are increasing. This not only counts for components and finished products but also for material developments that form the basis for new innovations with improved or new functionalities. The preliminary calculation of the characteristics profile of solids as a function of the synthesis parameters is currently only possible with insufficient accuracy. Therefore, product development in the field of material synthesis is performed predominantly via experimentation.

In this context, Fraunhofer UMSICHT is implementing the synthesis laboratory "ParMa" which is a quick development platform for the manufacturing of tailored particle materials. "ParMa" enables the wet-chemical production of micro capsules, effect pigments, fillers and reinforcing materials, nano particles, hydrogels, and polymer powders on the basis of parallel stirred vessel reactors equipped with extensive dispersion and process technology.

The transfer of combined methods, as they are known from the active ingredient screening in the pharmaceutical industry or the catalyst research, to material synthesis processes delivers detailed information on the influences of the process factors on the formation, growth, agglomeration, size reduction, or other form and function influencing processes during the production of

particular materials. The high degree of parallelization (up to 32 stirred reactors with 500 ml capacities) and computer supported recipe control allow systematic parameter studies and significantly reduced development times for particle systems. Identically constructed units are available in larger volumes (2 L, 15 L, 100 L) for safe up-scaling.

The synthesis laboratory "ParMa" strengthens the competency of the institute in the area of product development and offers industrial customers competitive advantages due to the short development times.

### Your contact

Dipl.-Ing. Jürgen Bertling  
(+49 2 08/85 98 -11 68)



The core of the platform is formed by the parallel reactor system equipped with efficient dispersion technology and automated sampling. Gravimetric dosing of solids and liquids, sensors for pH/value, temperature, pressure, turbidity, and units for the solid analysis supplement the research installation.

“The connected information technology provides businesses with useful tools to meet document or evidence obligations. With certainty!”

[Dr.-Ing. Stefan Schlüter, Business Manager Safety Engineering]



Our business is the safety-technological assessment and layout of industrial plants and processes, securing of pipeline systems, and the provision and maintenance of safety-relevant information.

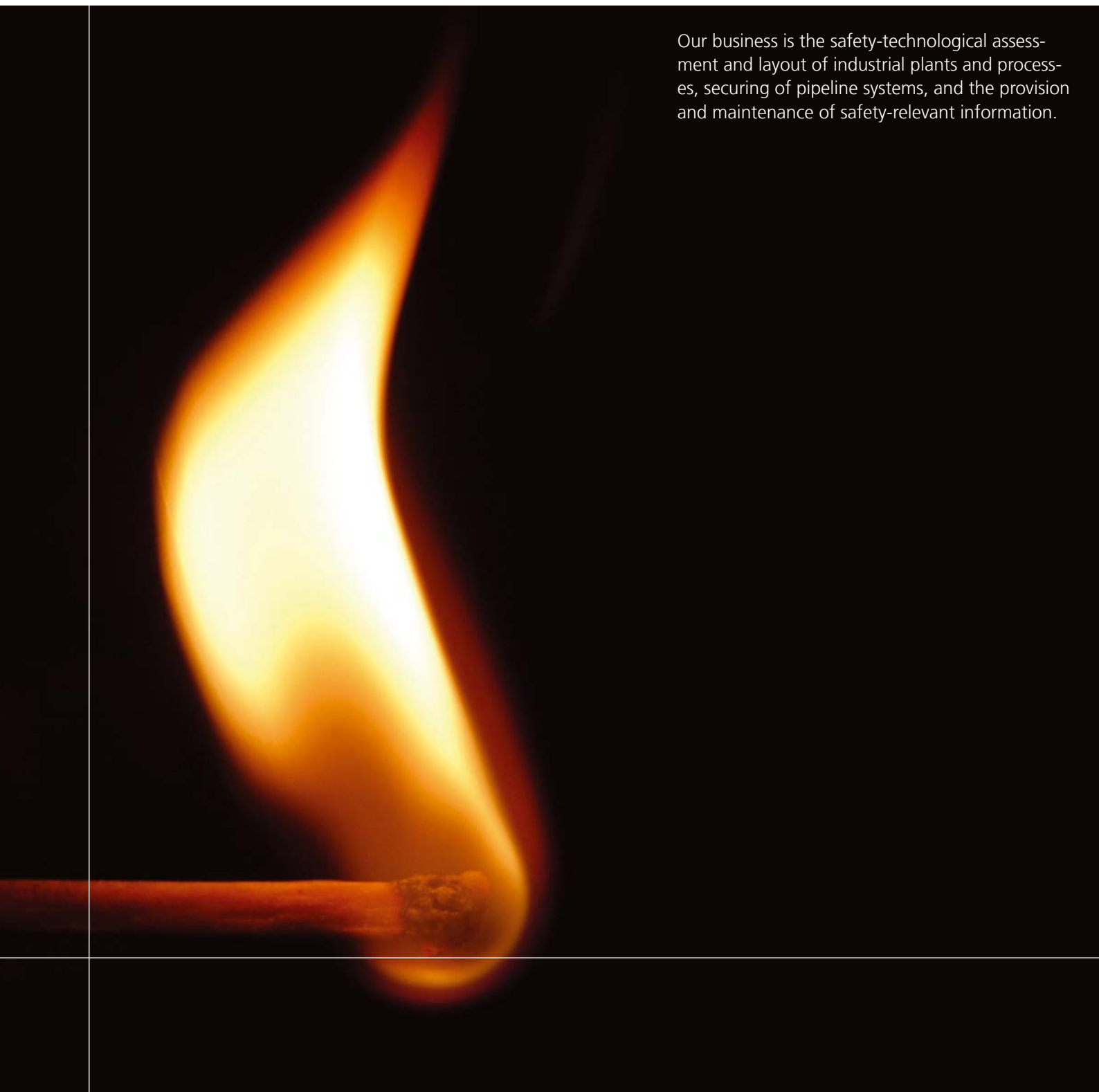

The Institute

Business Unit Renewable Resources

Business Unit Process Technology

Business Unit Waste Management/-Technology and Adsorption

Business Unit Advanced Materials

## Business Unit Safety Engineering

---

Fire and Explosion Protection

SAFETYprove: Efficient Fusion of Operational Management Systems

Fast and Safe Closing of Control Devices: Pressure Control Device (PCD)

Solutions for the Simulation of Heat Transport and Material Flow

Business Unit Energy Technology

Business Unit Energy Systems

Business Unit Know-how and Technology Transfer

Names, Data, Events



the present hazards. At the same time, hidden weak points were identified and solution suggestions were cooperatively formulated.

Our expertise combines scientific insights in the field of chemical engineering with in-depth knowledge of regulations supported by our own documentation and information systems. This enables us to develop industry-spanning assessments in the field of fire and explosion protection and appropriate, customer-specific solutions.

**Your contact**  
 Dr.-Ing. Ulrich Seifert  
 (+49 2 08/85 98 -11 27)

## Fire and Explosion Protection

The fact that sufficiently fine dispersion of flammable materials in the air represents an explosion hazard is well known. However, it is often new to business owners that they have to evaluate these hazards and possibly outline protective measures in an explosion protection document. Such are the requirements of the Hazardous Material Regulations and the Operational Safety Regulations. An in-depth evaluation of the fire and explosion hazards is especially important when several businesses operate at the same location where they could pose a danger to each other.

Fraunhofer UMSICHT supported different industrial sectors in the development of solutions and the hazard determination and documentation responsibility. The following examples will outline this:

Due to their height, silos are preferred locations for cell phone towers. In case flammable dusts are present in the silos, fire and explosion protection measures should be implemented that take the special conditions of the independent silo and cell phone tower operations into account. A new assessment system developed for that purpose was successfully used on many projects.

A business in the chemical industry was supported with the generation of uniform explosion protection documentation for various divisions in one location. A coherent zone classification was developed through a differentiated examination of



The combination of silos and ...

... cell phone towers is popular. This combination can make fire and explosion protection measures necessary.



The adherence to safety regulations is often not taken seriously enough.

## SAFETYprove: Efficient Fusion of Operational Management Systems

Management systems for quality, environmental protection, and occupational safety are inherent components of business organizations. They shape business policies, goals, and responsibilities and represent instruments for planning, steering, and success measurement as well as improvement. The success of these management systems is determined by the active employee participation because only "living" systems lead to a sustainable implementation. The situation-specific, target-oriented provision of all necessary information is crucial in this context.

This is where the SAFETYprove concept developed by Fraunhofer UMSICHT enters. It is based on the patented DUBAnet® platform which has already established itself on the market.

SAFETYprove forms the missing piece of the puzzle for an appropriate organi-

zation as required in connection with QMS, EMS und SMS<sup>1</sup>. SAFETYprove can be used to display and link the existing documents and processes in their complexity within the business. The establishment of linkages between employees, workstations, activities, etc. on one hand and documents and regulations on the other creates necessary transparency. Navigation mechanisms that are tailored to the business structure bundle the information flow and help individual employees to effectively access the information that is essential for their responsibilities.

The central supply of documentation ensures that only the most recent versions are accessible. Revisions and activity tracing occur centralized and are provided without redundancy. The time-consuming exchange of documents at individual workstations in the business is not necessary anymore. This saves effort, time, and money.

### Your contact

Dipl.-Phys. Thorsten Wack  
(+49 2 08/85 98 -12 78)

<sup>1</sup> QMS = Quality management system;  
EMS = Environmental management system;  
SMS = Safety management system

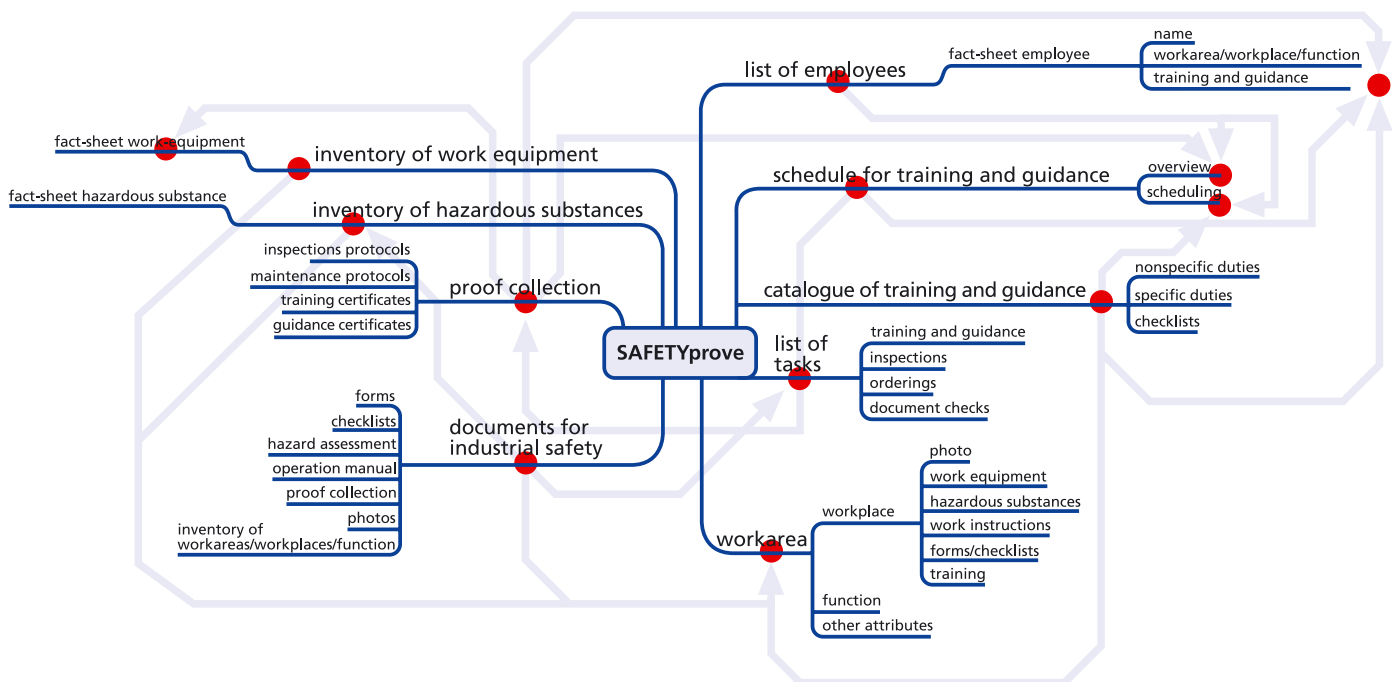

Linkage structure of organization units and processes in the business organization

## Fast and Safe Closing of Control Devices: Pressure Control Device (PCD)

The safe operation of pipeline networks is the basis for enabling the production and transportation of liquid and gaseous consumer goods and commodities of all types.

Water and cavitation hammer – often caused by valves closing too quickly – can significantly interfere with transportation safety by causing leaks. Production downtimes and even damage to humans and the environment are potential consequences.

In cooperation with the EBRO Armaturen GmbH based in Hagen, Fraunhofer UMSICHT is developing the Pressure Control Device (PCD), a technically safe and, compared to conventional measures, very inexpensive process for the dampening of high and low pressure peaks, for series-production readiness.

The process works as follows: The overpressure is directed to a passive control module via a stepping line. The control module constantly monitors the pressure in the main pipe during the closing of the valve and, in the case of excessive pressures, quickly prevents the valve

from closing further. Once the pressure in the pipe falls below a critical value, the valve closure is completed.

Using this method, the pipeline is closed as safely and quickly as possible without endangering humans or the environment. No electrical energy is needed for PCD-operation.

The system is currently being tested and fine-tuned by Fraunhofer UMSICHT. It will be commercially available in 2006.

### Your contact

Dr.-Ing. Andreas Dudlik  
(+49 2 08/85 98 -11 25)



PCD functional model (View from the front and back)

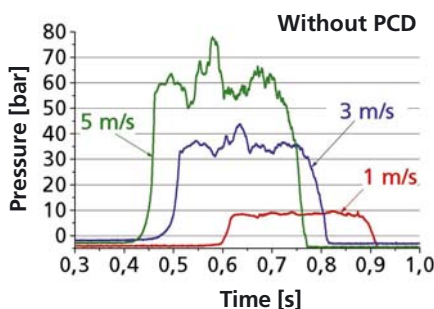

Pressure gradient without PCD

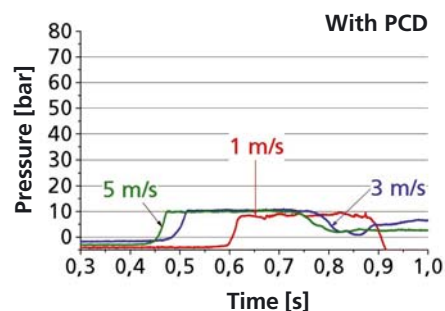

Pressure gradient with PCD

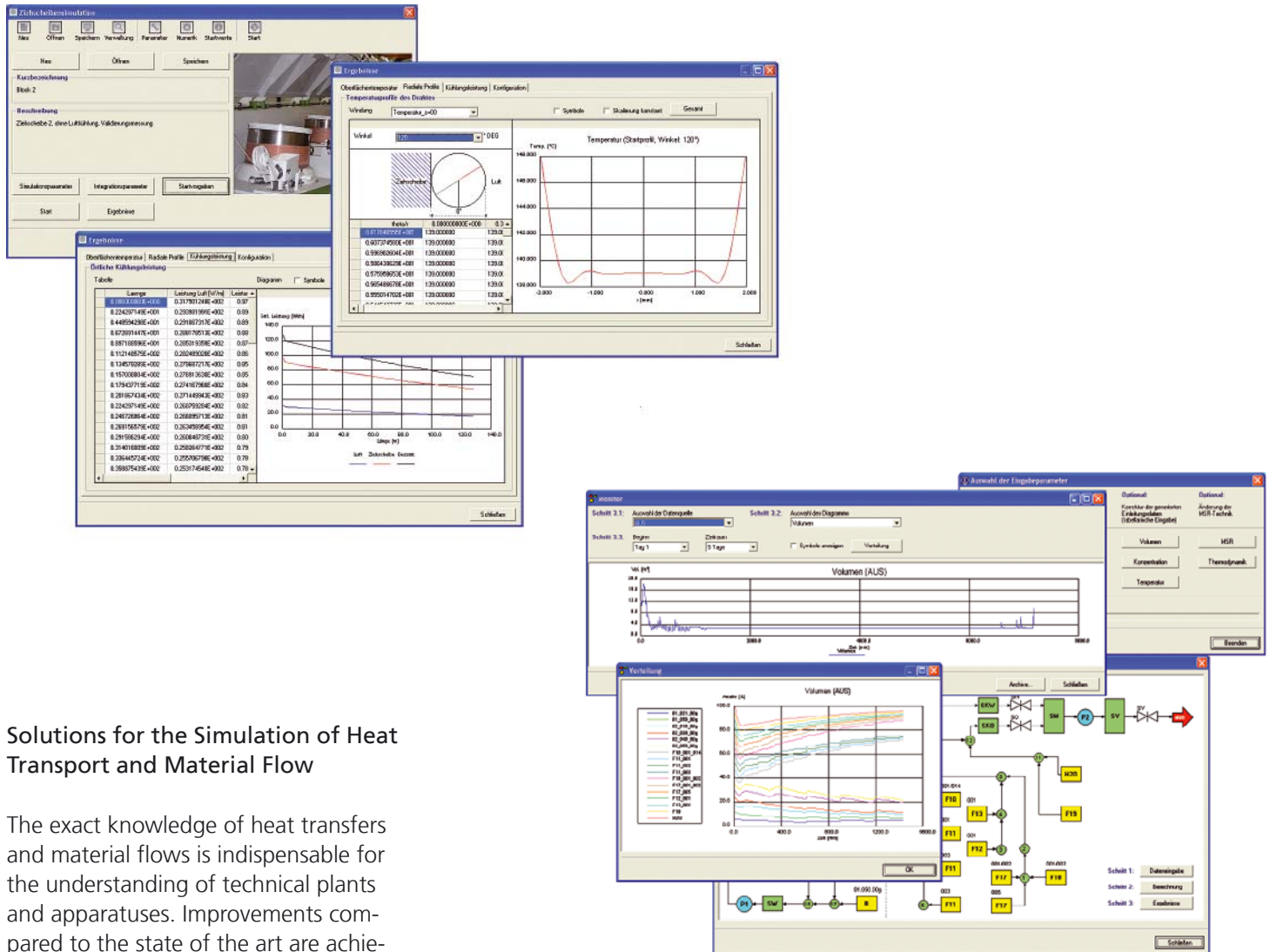

## Solutions for the Simulation of Heat Transport and Material Flow

The exact knowledge of heat transfers and material flows is indispensable for the understanding of technical plants and apparatuses. Improvements compared to the state of the art are achievable when the oftentimes complex interaction of heat and material of various components can be described in detail. Mathematical models should be accurate enough for the solution of the problem but also be realizable within in the budgeted time and monetary constrains.

In 2005, Fraunhofer UMSICHT developed special simulation solutions to calculate the thermal and material dynamics of plants and structural components for various customers and industries. The customer's goals were, for example, a better understanding of the process or the creation of a calculation basis for technical improvements. Two examples can clarify further:

A simulation solution that models the organic loading within a chemical company's wastewater network on a daily, weekly, and yearly basis was developed. The prediction is generated based on special discharge events and serves to develop a better process understanding as well as to optimize the operational wastewater handling.

As part of a project for a medium sized manufacturer of wire drawing machines, the temperature characteristics in the wire during various operations of the drawing process were modeled. It was important for the customer to identify

the influence of various components on the temperature characteristics in order to incorporate the findings into process improvement initiatives.

Scientific thermodynamics combined with the use of efficient mathematical and numerical procedures make it possible to develop solutions tailored to the specific needs of the customer within attractive time and cost budgets.

**Your contact**  
 Dr.-Ing. Stefan Schlüter  
 (+49 2 08/85 98 -11 26)



“Energy can neither be generated nor consumed. It can only be converted into various forms of energy. For this purpose we develop intelligent solutions for the future.”

[Dr.-Ing. Markus Ising, Business Unit Manager Energy Technology]

We develop energy conversion plants for highly efficient and economic electricity, heat and cold supply. Our strengths lie in the energetic utilization of biomass (wood and sewage sludge) and everything relating to the extraction, cleaning, and application of biogenic gases and low BTU gases.

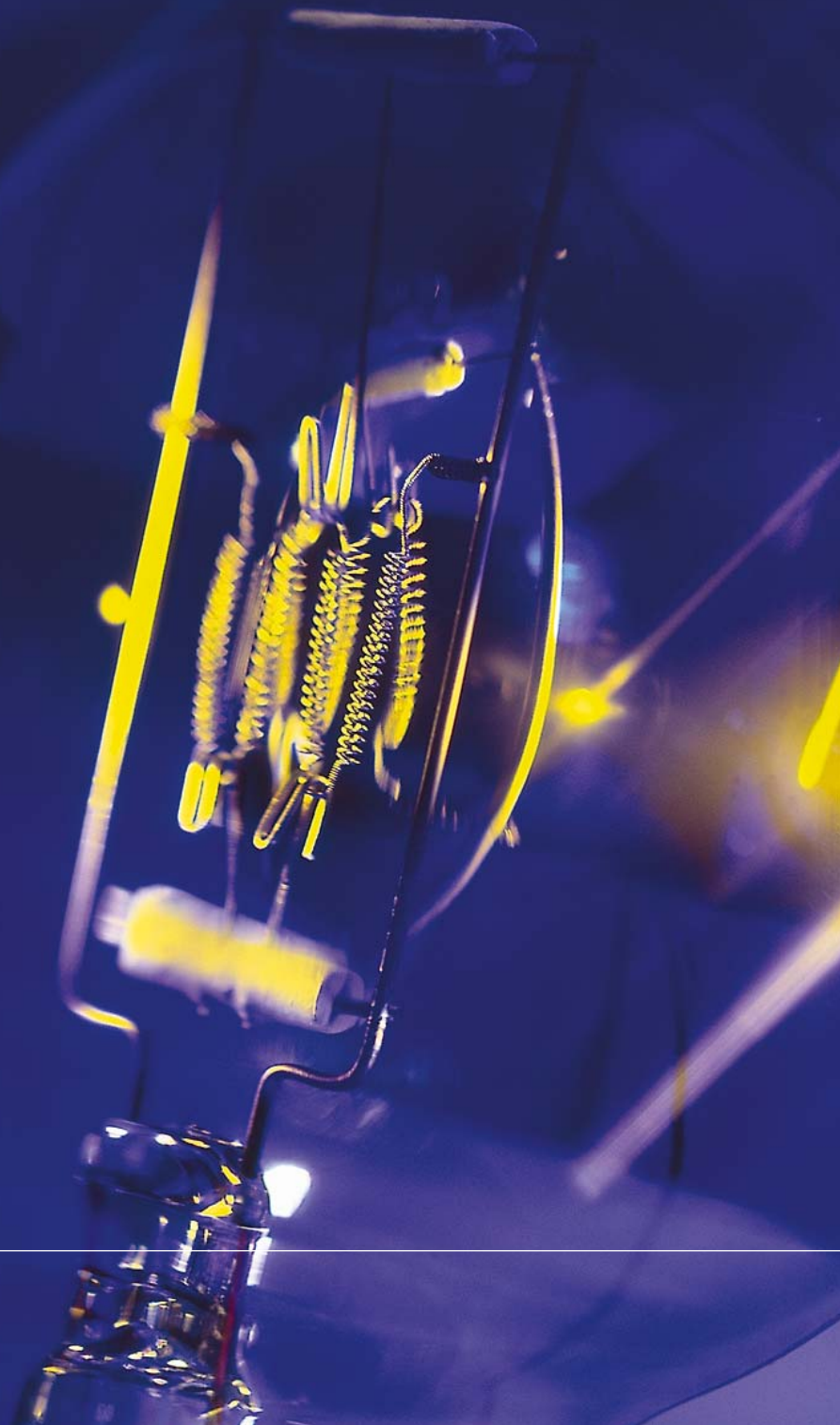



The Institute

Business Unit Renewable Resources

Business Unit Process Technology

Business Unit Waste Management/-Technology and Adsorption

Business Unit Advanced Materials

Business Unit Safety Engineering

## Business Unit Energy Technology

---

Polygeneration with the TRIG Process

Exploratory Drilling for Coal Mine Gas Recovery

Alternatives for the Generation of Biofuels

Generation, Treatment, and Supply of Biogas –  
Analysis and Evaluation

Business Unit Energy Systems

Business Unit Know-how and Technology Transfer

Names, Data, Events

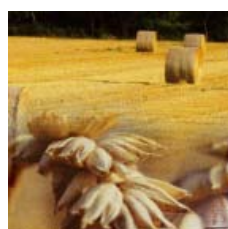

## Polygeneration with the TRIG Process

“Efficiency” is the key term in the energy debate concerning the conservation of fossil fuels and the economic utilization of renewable resources. A simple concept: The more energy one can harvest from the fuels, the more economical and environmentally friendly the process becomes. In the area of decentralized energy generation from sources such as solid biomass, this principle has already been practiced for a long time in the form of combined heat and power generation.

More is possible: If, in addition to heat and power, cold (CHPC) is generated from solid biomass, the efficiency increases noticeably. This has been shown in tests with natural gas driven CHPC plants. However, CHPC processes have been tested very little with solid biomass until now. This motivated the research team at Fraunhofer UMSICHT to develop the new TRIG Process. In collaboration with its partners from industry and science, a comprehensive study was performed to evaluate the process economically, environmentally, and with view to its applicability.

The goal of TRIG is to provide an optimized mix of heat, cold, and electricity in the middle capacity range (20 to 250 kW). At the core of the patented process (figure 1) is a conventional absorption heat pump (2) that is driven by the flue gas from a boiler at a temperature of 105 to 800 °C which can be fueled by wood chips for example. In the winter, the flue gas is cooled down to under 50 °C and heated up to a useful range of 60 to 80 °C from the released condensation heat of the contained steam (calorific value principle). During summer operation, the heat pump delivers cold for external users. Minor

additional investments lead to attractive income possibilities and higher plant efficiency.

All individual components of the TRIG process are well known and tested, whereas the adjustment of the components and the controlling of the entire system are entirely new. In order to accomplish that, different process variants were scientifically analyzed and thermodynamically modeled using energy and material balances (figure 2). The results are promising:

- An advantageous fluid pair for the absorption heat pump is ammonia/ water
- TRIG finds sensible applications in agriculture
- TRIG enables CHPC operation with improved economics
- TRIG is especially suitable for “unpopular” (e.g. wet, sulfurous) biomasses
- TRIG minimizes the CO<sub>2</sub>-emission and reduces local pollution
- TRIG has to be developed further technically and economically

Special thanks go to the German Mi-

TRIG – Trigeration with Integrated Gas condensation

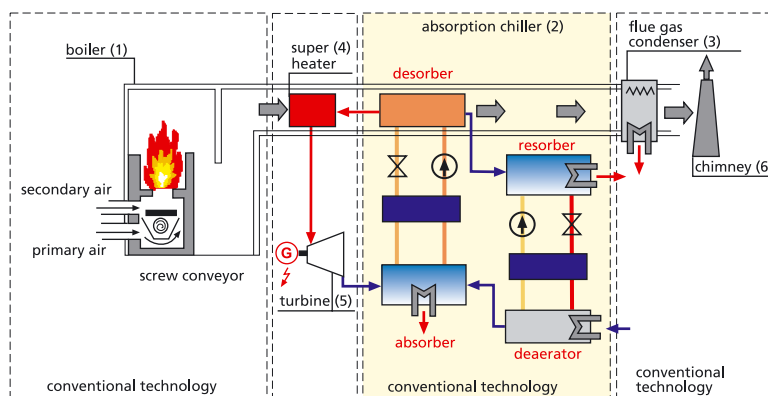

Figure 1: Example diagram of a TRIG plant

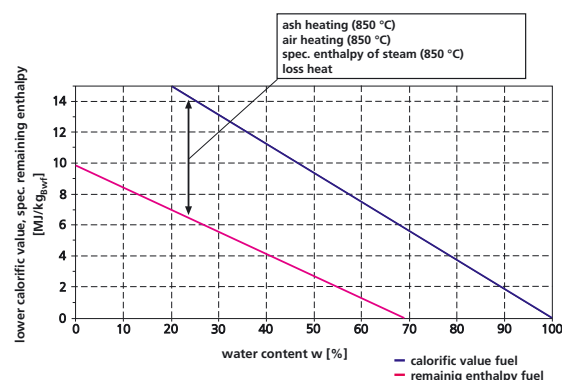

Figure 2: Dependency of the calorific value/remaining enthalpy content on the water content (Bwf = fuel, dry)

nistry for Environment, Nature Conservation, and Nuclear Safety which supported our efforts as part of the report “Retrofitting of existing wood boilers for low-emission CHP with heat utilization”.

### Your contact

Dr.-Ing. Markus Ising  
 (+49 2 08/85 98 -11 89)  
 Dipl.-Ing. Stefan Winter  
 (+49 2 08/85 98 -11 90)

## Exploratory Drilling for Coal Mine Gas Recovery



View of an exploratory drilling at the former Dorstfeld mine in Dortmund. Here coal mine gas is extracted night and day.



Since 1994, Fraunhofer UMSICHT has been overseeing the development of coal mine gas recovery<sup>1</sup> in the Ruhr Area. After the successful development in this field, increased efforts are being made to also recover mine gas from anthracite mines that do not have an open access to the atmosphere. The gas from these mines reaches the atmosphere through fractures in the overlying rock. In order to utilize this gas for energy generation, it has to be channeled to a certain location for recovery. This can be accomplished by drilling into a mine shaft or an old drift. The gas extraction from the borehole creates a pressure gradient in the direction of the borehole.

The partially intact drifts and galleries form a collection system for the gas that is released in the mine workings. During the test extraction of a borehole, data of the gas composition, amount and suction pressure build-up are collected. Using the results, forecasts for the extraction potential at that location are possible. These are used as the basis for the planning of a coal mine gas utilization plant.

The execution of the drilling requires a large amount of preparation. This is ac-

complished in collaboration with different parties where the geologic setting of the mountains and the layout of the former mine is of particular importance. The operation of a coal mine gas utilization plant requires expert know-how of numerous boundary conditions such that the current use is important for the selection of the drilling location. The harmonization of interests of the local governments, the land owners, and the involved companies has to be taken into consideration during the project development. Fraunhofer UMSICHT takes on an important coordinating function in this complex interaction.

### Your contact

Dipl.-Ing. Clemens Backhaus  
(+49 2 08/85 98 -11 88)

<sup>1</sup> Coal mine gas is the term for the gas mixture that occurs in coal mines. The mixture is mainly composed of methane, carbon dioxide, and nitrogen as well as traces of ethane, hydrogen, helium, and hydrosulfide.

## Alternatives for the Generation of Biofuels

The transportation sector accounts for 30 % of the total energy consumption and one fourth of the total carbon dioxide emission<sup>1</sup> in Europe. Therefore, the EU has been working on establishing biomass in the fuel market and on making a significant contribution to reaching internationally set climate protection goals through the utilization of renewable energy sources. In addition, biofuels reduce the dependence on mineral oil, increase the domestic added value, and create new income potential for the agricultural industry.

Up to 5 % of ethanol can be blended with gasoline for gasoline engines; up to 85 % can be used with modified engines; and up to 15 % can be mixed in as ETBE<sup>2</sup>. The fuel additive MTBE<sup>3</sup> is one of the most produced organic chemicals worldwide with an annual production of approximately 20 million tons. After banning MTBE in the USA, bioethanol is gaining increased importance in the fuel industry. However, the utilization of renewable raw materials is not free of controversy. Critics argue that net energy yield is low and that the eco-balance is unfavorable.

Based on this background, Fraunhofer UMSICHT is exploring the catalytic generation of ethanol from bio-synthesis gas as an alternative to competing processes or utilization options. Preliminary investigations showed that catalytic synthesis of ethanol from biomass shows a number of advantages compa-

Competing processes and alternative uses	Advantages of catalytic bioethanol generation
<b>Fermentative bioethanol production:</b> Suitable biomass is limited to starch and sugar based biomass.	<ul style="list-style-type: none"> <li>- higher production yield (<math>390 \text{ kg}_{\text{Ethanol}} / \text{t}_{\text{Biomass}}</math>)</li> <li>- 75% ethanol selectivity given that up to 42% of the biogenous carbon dioxide is utilized (based on lignocellulose; synthesis using a heterogeneous rhodium catalytic converter; without taking auxiliary power into consideration)</li> <li>- no incubation of yeast, bacteria, or fungi necessary</li> <li>- applicable to all types of biomass, i.e. also lignocelluloses such as wood</li> </ul>
<b>Bio-Syngas:</b> <ul style="list-style-type: none"> <li>- <b>Catalytic methane synthesis:</b> State of the art, diminishing acceptance in the fuel sector</li> <li>- <b>Fischer-Tropsch synthesis:</b> Technically very demanding, unestablished technology</li> </ul>	<ul style="list-style-type: none"> <li>- shift reactions necessary that use up some of the chemical energy: synthesis gases directly used for synthesis</li> </ul>
<b>Biomass in general</b>	<ul style="list-style-type: none"> <li>- no competition with the electricity industry</li> </ul>

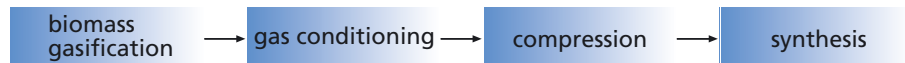

### gasification + conditioning



### synthesis

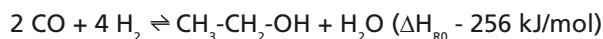
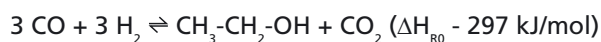

Basic process schematic for the alternative ethanol production

red to competing processes as can be seen in the table above.

In addition, since the installation costs of approximately 300-400 €/t are in a competitive range, further investigation of the process is warranted to answer questions regarding suitable catalysts, efficiency increase, selectivity optimization as well as byproduct utilization, minimum plant size, and biomass logistics.

### Your contact

Dr. rer. nat. Christoph Unger  
 (+49 2 08/85 98 -14 10)

<sup>1</sup> "Green Week" European Commission, June 1<sup>st</sup> 2005

<sup>2</sup> ETBE = Ethyl tertiary butyl ether

<sup>3</sup> MTBE = Methyl tertiary butyl ether

## Generation, Treatment, and Supply of Biogas – Analysis and Evaluation

Increased use of renewable energy is a central component for the development of sustainable energy systems. Biomass has been gaining national and international significance for energy suppliers as an energy carrier because it is renewable and therefore inexhaustible, CO<sub>2</sub> neutral, usually storable, and also offers many utilization possibilities.

Within the large spectrum of biomass, the use of biogas for energy supply is mainly discussed in association with the fermentation of residues such as manure or biowaste. In addition, traditional biogas utilization based on electricity supply for consumers located in the immediate vicinity of the biogas plants is viewed as limited. In the near future, new possibilities can arise when energy plants (renewable resources) are increasingly employed and biogas can be upgraded for feeding it into the natural gas grid. In this manner, new consumers can be supplied who do not necessarily have to be located nearby a biogas plant.

On this basis, the study for the “Analysis and evaluation of the utilization possibilities of biomass” was funded by the Bundesverband der deutschen Gas- und Wasserwirtschaft (Federal Association of German Gas and Water Supply, BGW) and the Deutsche Vereinigung des Gas- und Wasserfachs (German Technical and Scientific Association for Gas and Water, DVGW). Its goal was to identify environmentally and economically sensible options for utilizing biomass with special consideration to the potential for feeding biogas into the existing natural gas grid.

The authors of the study<sup>1</sup> came to the conclusion that the most economical way to use biomass is to feed the produced biogas into the natural gas

grid for centralized electricity and heat generation. Assuming funding through the Renewable Energy Law (Erneuerbare Energien Gesetz [EEG]), the success of the expansion of existing biogas plants is dependent on prices of agricultural raw materials. A targeted and efficient use of agricultural land makes a biogas contribution of 100 billion kWh per year which is equivalent to 10% of the current natural gas sales in Germany appear possible under positive assumptions. The investigators also came to the conclusion that biogas production from manure fermentation has the highest environmental protection potential in the form of climate protection.



The study “Analysis and evaluation of the utilization possibilities of biomass” can be accessed online at: [www.bgw.de/de/presse](http://www.bgw.de/de/presse)

Fraunhofer UMSICHT investigated aspects of biomass gasification, technologies and costs for gas upgrading, and potential biogas feeding in Germany as part of the study.

### Your contact

Dipl.-Ing. Wolfgang Urban  
(+49 2 08/85 98 -11 24)

<sup>1</sup> Wuppertal Institute for Climate, Environment, and Energy (project coordination); Institute for Energy and Environment, Leipzig; Fraunhofer Institute for Environmental, Safety, and Energy Technology UMSICHT, Oberhausen; Gas-Heat Institute, Essen

“Our future will be characterized by sustainable and safe energy supply. We develop modular technologies and integrate them into already existing energy systems.”

[Dr.-Ing. Christian Dötsch, Business Unit Manager Energy Systems]



The general economic, political and technical conditions in energy supply are changing. The economic and sustainable future of the energy industry can only be ensured by developing efficient strategies to adapt existing and new energy systems to the changed situation.



The Institute

Business Unit Renewable Resources

Business Unit Process Technology

Business Unit Waste Management/-Technology and Adsorption

Business Unit Advanced Materials

Business Unit Safety Engineering

Business Unit Energy Technology

## Business Unit Energy Systems

---

Energy Benchmarking: More than a Number

Thermal Chillers for Solar Cooling and Combined Heat, Cold,  
and Power Generation

Decision Support for the Energy Management

Coolants in a Class of their Own

Business Unit Know-how and Technology Transfer

Names, Data, Events

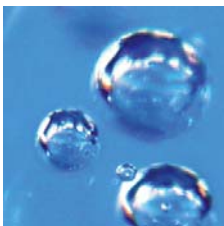

## Energy Benchmarking: More than a Number

Efficient energy utilization plays a crucial role for many businesses due to sky-rocketing energy costs. There are a number of measures and technologies available for the optimization of energy supply. Therefore, businesses have to ask themselves how to reduce energy costs while keeping expenses at a justifiable level.

Benchmarking offers the possibility to learn from the best. To accomplish the characteristic key data that individually describe a plant, a process or a business unit are compared. By comparing them with other businesses, previous experiences can be taken advantage of and promising solutions can be identified. Savings successes and economical risks can be assessed early.

After Fraunhofer UMSICHT had already compared key data from waste incineration plants for example, the method of key data comparison is currently being developed further. A multi-criteria approach is used to take the assessment of the characteristic properties of the analyzed objects into consideration. Different energetic processes are made comparable by benchmarking with re-

Comparison of hospitals

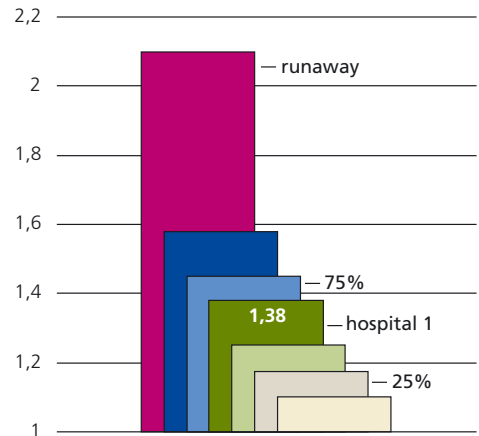

Standardized energy conservation potential of hospital 1 in relation to the optimum consumption (1 = optimum value)

ference processes so that even complex systems can be reduced down to key data and contrasted.

An interesting field of application is the comparison of hospitals because they exhibit large energy conservation potential. The cause for that are frequent building expansions and modifications as well as a large fraction of old plants in need of modernization. The developed method makes it possible to identify worthwhile cost reduction potential and to highlight promising optimization approaches. Additional, interesting fields of application are in the area of energy intensive processes and operations such as in foundries, breweries as well as the cement and paper industry.

### Your contact

Dipl.-Ing. Carsten Beier  
(+49 2 08/85 98 -14 16)

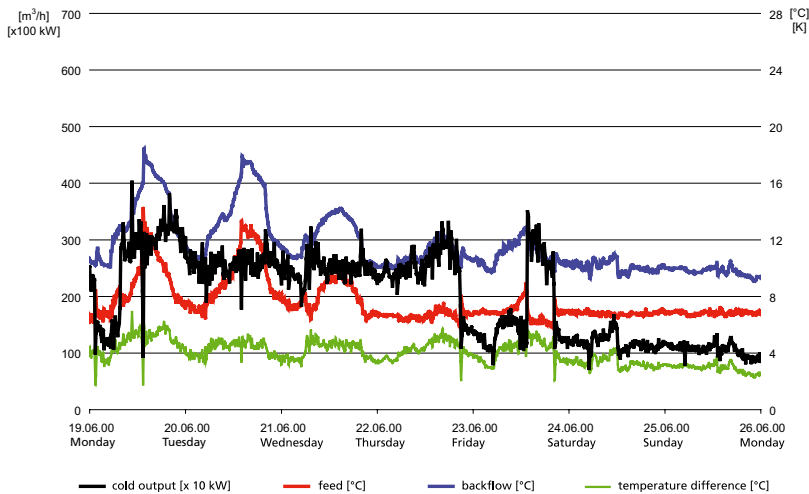

Measured data show energy consumption and form the basis for energy optimization.



## Thermal Chillers for Solar Cooling and Combined Heat, Cold, and Power Generation

Rising demands in living standards and a changing energy supply picture are making thermal chillers, which are driven by solar, waste or district heat, the focal point of the cooling and air conditioning industry. The reason for the increased attention is that thermal chillers make a significant contribution to rational and sustainable energy supply because they are driven by heat instead of electricity. In addition, they offer interesting options from an economic point of view. The potential cost reductions by utilizing solar cooling are especially attractive in hotter climates such as in the Mediterranean area.

Fraunhofer UMSICHT has been working with cooling processes such as water-LiBr-absorption or the steam jet ejector process for years. The steam jet ejector is an especially interesting alternative to other sorptive cooling processes used until now for generating cold water, which is why Fraunhofer UMSICHT has been working hard to advance its development.

In addition to pilot plants and feasibility studies, several demonstration plants have been set up. (Paper Plant Koehler AG: 1 MW<sub>th</sub>, cooling supply Gera: 1,2 MW<sub>th</sub>, solar cooling: 58 kW<sub>th</sub>).

Currently, Fraunhofer UMSICHT is developing a compact steam jet ejector plant in a container (planned cooling capacity: 100 kW<sub>th</sub>). The goal of the project is to achieve cost reductions through standardization and optimization. In another project funded by the Deutsche Bundesstiftung Umwelt DBU, a small pilot plant (cooling capacity: 100 kW<sub>th</sub>) is used to explore the combination of parabolic solar collectors with a steam jet ejector to achieve competitive solutions.

### Your contact

Dr.-Ing. Peter Noeres  
(+49 2 08/85 98 -11 87)  
Dipl.-Ing. Clemens Pollerberg  
(+49 2 08/85 98 -14 18)

Steam jet ejector: interesting alternative to conventional sorptive cooling processes



## Decision Support for the Energy Management

High competitive pressure in the energy market, rising prices and volumes, and changing social and political conditions necessitate energy management strategies which hold up to changing conditions. Therefore, decisions for solving complex tasks in planning and management are increasingly supported by system modeling, scenarios, and simulations that are based on modern, stochastic mathematical approaches.

The goal of the new research initiative of the Federal Ministry of Education and Research (BMBF), called "Network for basic research on renewable energy and rational energy utilization", is to better utilize renewable energy. Since June 2005, Fraunhofer UMSICHT has been working with a team of scientists from the University of Duisburg-Essen, the Humboldt University of Berlin, the Ruhr University of Bochum, the TU Darmstadt, and the University of Dortmund on new stochastic optimization processes for the design and operation of energy systems with a large portion



of renewable supply. One of the focal points of the work is the optimal back-up for fluctuating sources using technical means (storage, control) and with methods of decentralized energy and risk management.

Scenario-based stochastic optimization also forms the core of the IT-tool "SpOt" with which risk management of electricity procurement portfolios can be automated. Based on a characteristic risk aversion<sup>1</sup>, »SpOt« determines the best possible backup using derivations<sup>2</sup>. »SpOt« was developed in collaboration with the partners sas and Capgemini for smaller market participants in the electricity market. In order for them to stay competitive, they have to take more advantage of opportunities in electricity trading and buy electricity at the market price. Handling the related price risks requires a secure portfolio

management which until now has been associated with a disproportionate effort for industrial users and utilities.

The application of methods for analyzing energy systems under consideration of given uncertainties is also a main focus for the Fraunhofer Alliance "Energy". Their concentration is on control and operational behavior of complex systems such as the control of distributed power plants or the optimal integration of the fluctuating feed of renewable energy carriers.

The European emission trade that started in 2005 is an important change in framework of the energy business. Fraunhofer UMSICHT consults over 25 businesses with the strategic and operational implementation of their CO<sub>2</sub>-management. CO<sub>2</sub>-monitoring und risk management were the focal points of our consulting activities.

### Your contact

Dipl.-Ing. Michael Lucht  
(+49 2 08/85 98 -11 83)  
Dr.-Ing. Christian Dötsch  
(+49 2 08/85 98 -11 95)

<sup>1</sup> Risk-aversion is a measurement of the tendency of a decision maker to reduce risks in the face of lower return expectations.

<sup>2</sup> A derivation is a financial instrument. Its value depends on future price expectations of a (energy) product.



[ stochastic portfolio optimization tool ]

## Coolants in a Class of Their Own

The rapidly growing cooling market has increased the demand for innovative, cost-reducing solutions for cold storage and distribution. Currently, conventional agents such as water and brines are still the primary cold carriers in use. They store thermal energy proportionally to the heating capacity and are used in a narrow, clearly defined temperature range. This translates into large volume flows and thus large pumping and energy requirements for applications which only work in narrow temperature bands.

For the past several years, phase change slurries (PCS)<sup>1</sup> have been gaining attention in cooling technology. These slurries go through a phase change in the required temperature range and break up the linear relationship between transported heat and temperature spreading. Compared to conventional heat carrier fluids, PCS can store much more energy per unit volume and thus create potential for energy savings and cost reductions for plant design.

Ice slurries, a special type of PCS, have gained particular commercial significance in cooling technology. They are based on a mixture of water and antifreeze and utilize the phase change from water to ice during heat transport. Based on the materials, its application is limited to a temperature range of approximately -15 °C and 0 °C. During the research activities in the area of cold storage over the last five years, Fraunhofer UMSICHT has developed CryoSol<sup>®</sup>, an ice-slurry that is liquid, pumpable and non-poisonous. CryoSol<sup>®</sup> can be used for process cooling near the freezing point. It is ideally used for all applications where high cooling capacity is needed for short time periods such as air conditioning, the chemical industry, and the food industry.



Currently, Fraunhofer UMSICHT is working on new concepts for PCS that contain paraffin emulsions or alternatively ionic liquids as phase-change materials<sup>2</sup> which would be used in the temperature range of 0 °C and +18 °C. The goal of the research for the paraffin emulsion is to create a thermally tested and characterized liquid optimized for cold carrier applications. For the ionic liquids, the aim is material screening and first laboratory tests.

### Your contact

Dr.-Ing. Christian Dötsch  
(+49 2 08/85 98 -11 95)

<sup>1</sup> PCS are heat carriers that are made up of a phase change material (PCM). The phase change is typically a solid-liquid transition.

<sup>2</sup> Phase change materials (PCM) go through a phase change in a defined temperature range and, thereby, store large amounts of heat energy nearly isothermally, i. e. the temperature stays nearly the same.

“Economic growth arises from creative ideas. We support the world-wide implementation and marketing of these ideas through networking and international project development.”

[Dr.-Ing. Achim Loewen, Business Unit Manager Know-how and Technology Transfer]



We combine modern management techniques with technology know-how, transfer know-how of the institute into national and international research and development projects, and drive the development and dissemination of technologies, which are adapted to the special needs of the particular countries.



The Institute

Business Unit Renewable Resources

Business Unit Process Technology

Business Unit Waste Management/-Technology and Adsorption

Business Unit Advanced Materials

Business Unit Safety Engineering

Business Unit Energy Technology

Business Unit Energy Systems

## Business Unit Know-how and Technology Transfer

---

Network for Gas Treatment Technologies and Processes "ReGasNet"

European Waste Sector Assistant EUWAS

Working Group for Applied Activated Carbon Technologies (AFATEC)

Support of Research Cooperation within the EU

Names, Data, Events

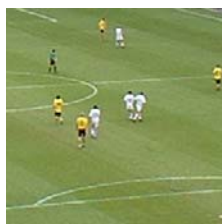

# Network for Gas Treatment Technologies and Processes "ReGasNet"

## Network for Gas Treatment Technologies and Processes "ReGasNet"

"The share of regenerative low BTU gases in the total energy supply portfolio should increase significantly". This is the goal of 14 German and Polish research organizations that have come together in a network for gas treatment technologies and processes ReGasNet<sup>1</sup> under the management of Fraunhofer UMSICHT.

The energetic potential of the regenerative low BTU gases including bio, landfill, and sewage gas as well as raw gas from biomass gasification is used only in a limited capacity due to the sensitivity of the power plants to harmful gas constituents. The gases represent an important form of renewable energy because they are suitable for a variety of applications such as fueling motors, fuel cells and other aggregates. Prior to tapping their potential, the gases have to be treated and cleaned. The type and extent of the pretreatment depend on the initial gas quality as well as the requirements of the power plant.

The focus of the work within ReGasNet lies in the systematic research and

development of suitable gas treatment processes. Individual, selected research and development projects are realized on the basis of promising utilization options. Subsequently, a systematic evaluation of the research results and the state of the art is carried out. Based on developed key data and indicators, assessments and comparisons of various gas treatment and upgrading processes are completed. The goal is to identify and optimize promising technologies and to overcome obstacles and knowledge gaps that interfere with future application.

Based on the achieved results, gas treatment technologies and process combinations will be selectively advanced following the first phase of network activities.

### Your contact

Dr.-Ing. Barbara Zeidler  
(+49 2 08/85 98 -11 43)

[www.regasnet.de](http://www.regasnet.de)

<sup>1</sup> ReGasNet is funded by the Federal Ministry for Education and Research (BMBF)



Kick-off meeting of the network for gas treatment technologies and processes for the utilization of gases from renewable resources.

## European Waste Sector Assistant EUWAS

The notion of a united Europe presumes the exchange of knowledge and experience on an international level. The accession of the first ten Eastern European countries significantly increased the amount of technological information and data information about European tenders and programs as well as the need for know-how about European administration processes. In order to meet this knowledge demand, non-networked and decentralized information sources are often used. However, this type of investigation does not always lead to acceptable results and is often associated with great time expenditures.

In order to optimize the international information exchange in the area of waste management, Fraunhofer UMSICHT is developing and coordinating the internet-based knowledge and information portal "EUWAS – European Waste Sector Assistant" in cooperation with eight European partners. The two-year project is funded by the EU-Commission as part of the EU program eContent, which focuses on the dissemination, generation, and utilization of digital contents on European level.

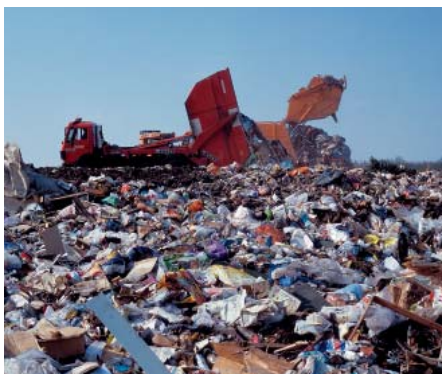

Want to improve the information flow in the European waste industry: the creators of the knowledge and information portal "EUWAS".

The project goal of the EUWAS platform is:

- to bundle decentrally offered waste management data, make it more userfriendly, and to offer it centrally (one-stop-shop);
- to promote the co-operation of public and private sectors in the area of waste disposal within Europe;
- to support the exchange of knowledge and experience for businesses and communities in the waste management field within Europe through the creation of a subject-specific internet platform; and
- to facilitate the daily work within the European waste disposal industry.

In addition to features such as a business partner exchange and tender platform, regulation text search, "best practice" solution and process information database, the user can take advantage of "step by step guides".

Based on this online support, the EUWAS-user can comfortably and quickly research extensive information with his computer. This can, for example, support his or her efforts in developing and writing proposals for EU tenders or in realizing waste management plans.

### Your contact

Dr. rer. nat. Sylke Palitzsch  
(+49 2 08/85 98 -14 11)  
Dipl.-Geogr. Simone Krause  
(+49 2 08/85 98 -11 36)

[www.euwas.org](http://www.euwas.org)



# Working Group for Applied Activated Carbon Technologies (AFATEC)

## Working Group for Applied Activated Carbon Technologies (AFATEC)

Activated carbons are excellent for the removal of unwanted colors, flavors, or aromas from gases, steams, and liquids. They consist of pure carbon and, due to their porous structure, contain an enormous interior surface area on which molecules can adsorb. New, doped, and catalytically active microporous activated carbons open new markets for products and processes. This is where the working group for applied activated carbon technologies (AFATEC) enters. The network of seven businesses along the value-added chain of raw material processing – semi-finished product production – energy supply – specialty construction and assembly as well as distribution is focusing on these new activated carbons. It sees main applications in the treatment of water and air and in odor control.

Fraunhofer UMSICHT coordinates – financially supported by the German Ministry for Economy and Labor – the efforts within the network and performs the following services for the participating businesses:

- Outside presentation of the network
- Identification of new contacts, project partners and the acquisition of new customers
- Identification of funding options for innovative project ideas
- Identification of project and product ideas including their implementation and the opening of markets
- Organization of individual tasks and completion of network tasks



Air filters with activated carbon eliminate pollutants, dust, disturbing odors, etc. from air.

During the build-up period of the network, an outstanding collaboration of the network participants and the initiation of multiple projects and endeavors already took place. For example, a new type of odor filter for wastewater plants, a filter system for odor control in biogas plants, exchangeable activated carbon

filters for various applications, small, textile-based filters that are open to diffusion, and new ammonia filters for hog feeding operations were developed.

### Your contact

Dr. rer. nat. Sylke Palitzsch  
(+49 2 08/85 98 -14 11)



The interior surface area of 6 grams of high-quality activated carbon is equivalent to the area of a soccer field.



## Support of Research Cooperation within the EU

After the accession of the first ten Eastern European Countries to the EU on May 1<sup>st</sup> 2004, there has been an increase in activities to improve the integration of researchers from the new member states into the European research area and to initiate collaborative projects with institutions from the old member states. In this context, Fraunhofer UMSICHT in collaboration with various partners is carrying out special programs that bring together research groups from the old and the new EU countries in order to benefit from each other's know-how and to develop project ideas together.

One example is the project »Integration 4 Water« which is funded by the European Commission and managed and carried out by the Institute for Ecology of Industrial Areas IETU in Katowice, Polen. As part of this project, an internet portal was developed with which researchers from the new member states can enter their research topics and references in the area of water treatment. Interested parties from the old member states can use the portal to directly search for partners to collaborate with in EU-projects. Currently, a workshop is planned for spring 2006 in which project ideas and research focus points in the area of water for the 7<sup>th</sup> Research Framework Program of the EU will be discussed. The portal and additional information can be found at [www.integration4water.org](http://www.integration4water.org).

An additional event, funded by the Foundation for German-Polish Cooperation and the International Bureau of



The outside temperatures were frosty. However, the German and Polish participants quickly warmed up during numerous cooperation talks at the "German-Polish Brokerage Event".

the BMBF (Federal Ministry for Education and Research), was held in November 2005. Approximately 20 German and 20 Polish participants from the areas of research and development as well as representatives from technology oriented small and medium-sized enterprises came to the »German-Polish Brokerage Event« and received information on current EU funding opportunities for scientific-technological cooperations based on renewable energy sources and energy efficiency. A substantial element of the event was to directly facilitate discussing between potential partners from Germany and Poland.

### Your contact

Dr.-Ing. Achim Loewen  
(+49 2 08/85 98 -11 52)



»A book is like a garden  
carried in a pocket.«

[Arabian proverb]

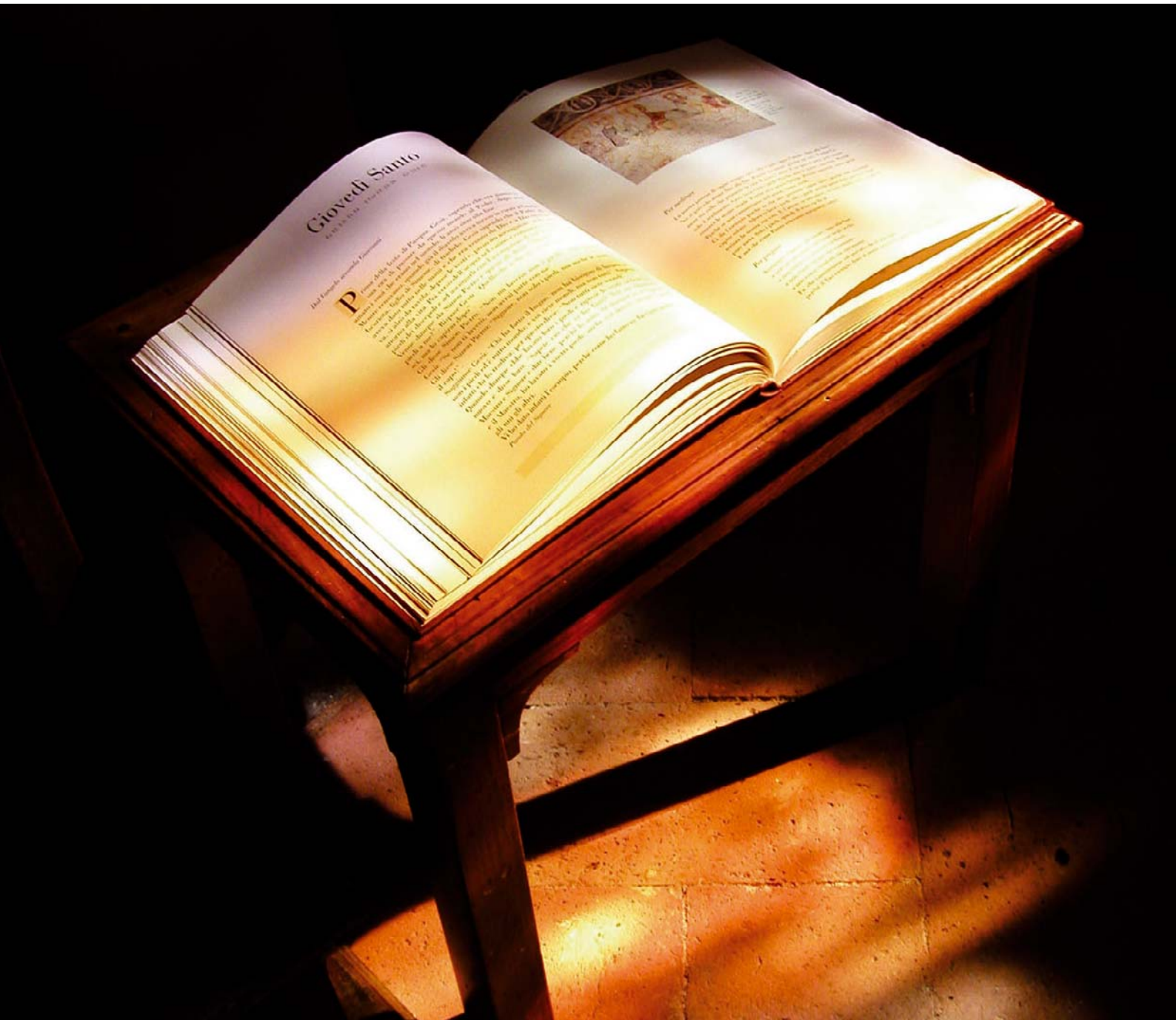

The Institute

Business Unit Renewable Resources

Business Unit Process Technology

Business Unit Waste Management/-Technology and Adsorption

Business Unit Advanced Materials

Business Unit Safety Engineering

Business Unit Energy Technology

Business Unit Energy Systems

Business Unit Know-how and Technology Transfer

## Names, Data, Events

---

Publications

Selected Clients, Contacts and Circle of Friends and Patrons

Patents

Spin-offs

How to Find Us

Guidelines

The Fraunhofer-Gesellschaft

Board of Trustees

Imprint

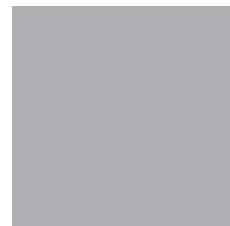
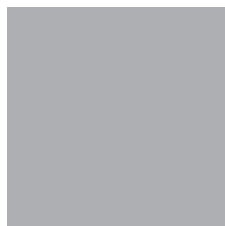
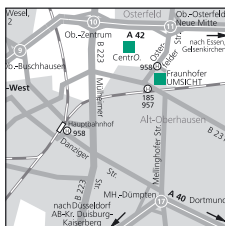

## Publications

*The following survey only includes lectures and publications which were written and/or delivered in English. For a complete bibliography, see the German version of our annual report.*

## Publications

Beard, A.\*; Marzi, T.:

**New phosphorus based flame retardants for E&E applications: A case study on their environmental profile in view of European legislation on chemicals and end-of-life (REACH, WEEE, ROHS)**

(International Plastics Additives and Modifiers Conference (Addcon) <11, 2005, Hamburg>)  
In: Addcon 2005, the 11<sup>th</sup> International Plastics Additives and Modifiers Conference: Hamburg, Germany, 21-22 September 2005. Shawbury: Rapra Technology Ltd., 2005, p. 14 (Paper 22)  
\*Clariant GmbH, Hürth

Cerce, T.\*; Peter, S.\*\*; Weidner, E.:

**Biodiesel-transesterification of biological oils with liquid catalysts: Thermodynamic properties of oil-methanol-amine mixtures**

In: Industrial and Engineering Chemistry Research, 44 (2005), No. 25, p. 9535-9541  
\*Ruhr-University Bochum  
\*\*University of Erlangen

Dudlik, A.; Neuhaus, T.:

**Experiments and comparing calculations on thermohydraulic pressure surges in pipes**

In: Lemonnier, Herve (Ed.): Eleventh international topical meeting on nuclear reactor thermal hydraulics. Log Number 540. 1 p.

Keldenich, K.; Marzi, T.:

**Combustion behaviour of refuse derived fuels (RDF) – development of a characterisation method**

In: VGB Power Tech, 85 (2005), No. 4, p. 90-94

Krause, S.; Eimer, U.\*:

**European waste sector assistant – EUWAS: Implementation of a web-based knowledge management system for the European waste sector**

(International Conference Informatics for Environmental Protection (EnvirolInfo) <19, 2005, Brno>)  
In: Hrebicek, J.: Informatics for environmental protection: Networking environmental information; proceedings of the 19<sup>th</sup> International Conference Informatics for Environmental Protection, September 7-9, 2005, Masaryk University of Brno, Czech Republic; EnvirolInfo Brno 2005. Brno: Masaryk University Brno, 2005, p. 406-410  
\*Umweltamt Stadt Hagen

Lucht, M.; Spangardt, G.; Handschin, E.\*:

**Applications for Stochastic Optimization in the Power Industry**

In: Electrical engineering: Archiv für Elektrotechnik; research journal 88 (2005), No. 3, p. 177-182  
\*University of Dortmund

Marzi, T.; Palitzsch, S.; Keldenich, K.; Kümmel, R.; Pellens, J.\*; Bleeker, P.\*\*:

**Rapid aging of bottom ashes from municipal solid waste incineration – a large-scale test**

In: Lechner, Peter (Ed.): Waste Management in the Focus of Controversial Interests. Austria: Facultas Verlags- und Buchhandels AG, 2005, p. 291-305  
\*Essent Milieu Bouwstoffen, Halen, Netherlands  
\*\*Insulinde Recycling en Milieu, Amsterdam, Netherlands

Neuhaus, T.; Dudlik, A.; Tijsseling, A.\*:

**Experiments and corresponding calculations on thermohydraulic pressure surges in pipes**

In: CASA Reports (2005), 05-45, p. 27  
\*TU Eindhoven

Pollerberg, C.; Noeres, P.; Doetsch, C.:

**PCS-Systems in cooling and cold supply networks**

(Workshop on Ice Slurries <6, 2005, Yverdon-les-Bains>)  
In: International Institute of Refrigeration -IIR-: Sixth Workshop on Ice Slurries 2005: Of the International Institute of Refrigeration. Proceedings of an international meeting in Yverdon-les-Bains, Switzerland, June 15-17, 2005. Yverdon-les-Bains, 2005, p. 14 ff

Tello, H.\*; Unger, A.\*\*; Gockel, F.\*\*\*; Jelen, E.:

**Decontamination of ethnological objects with supercritical carbon dioxide**

In: ICOM Committee for conservation: 14<sup>th</sup> Triennial Meeting The Hague. London : Earthscan – James & James, 2005, p. 110-119  
\*Staatliche Museen zu Berlin, Ethnologisches Museum  
\*\*Staatliche Museen zu Berlin, Rathgen-Forschungslabor  
\*\*\*Messer group GmbH (Messer Frankreich), France

Tello, H.\*; Jelen, E.; Unger, A.\*\*:

**Decontamination of ethnological collections using supercritical carbon dioxide**

In: Collection Forum 19 (2005), 1-2, p. 45-48  
\*Staatliche Museen zu Berlin, Ethnologisches Museum  
\*\*Staatliche Museen zu Berlin, Rathgen-Forschungslabor

Wack, H.:

**Water-swellable materials – application in self-repairing sealing systems**

(International Conference on Fluid Sealing <18, 2005, Antwerp>)  
In: Hoyes, J.: Sealing for pollution prevention and control: 18<sup>th</sup> International Conference on Fluid Sealing, Antwerp, Belgium, 12-14 October 2005. Cranfield: BHR Group, 2005. (Transferring technology), p. 359-366

Wigbels, M.; Bøhm, B.\*; Sipilä, K.\*\*:

**Dynamic heat storage and demand side management strategies**

In: Euroheat & power. English edition, 3 (2005), No. 2, p. 58-61  
\*Department of Mechanical Engineering, Technical University of Denmark  
\*\* VTT Processes, Finland

Zafar, K.; Blömer, J.; Bertling, J.:

**Population balance modelling of micro-encapsulation process**

(Symposium Partikeltechnologie; (<Pfinztal: 2004.07.17-18>)  
In: Teipel, Ulrich: Produktgestaltung in der Partikeltechnologie: Band 2, Stuttgart: Fraunhofer IRB Verlag, 2005

## Selected Clients, Contacts and Circle of Friends and Patrons

### Selected Clients and Contacts

#### A

A. und E. Lindenberg GmbH & Co. KG, Bergisch-Gladbach  
 Abfallbehandlung Nord GmbH, Bremen  
 AdFIS Adsorptive Filtersysteme GmbH, Teterow  
 AEG SVS Power Supply Systems GmbH, Warsten-Belecke  
 AGR Deponienachsorge GmbH & Co. KG, Herten  
 Agrar-Energie-GmbH & Co. KG, Hopsten  
 AiF Arbeitsgem. industrieller Forschungsvereinigungen Otto von Guericke e. V., Berlin  
 Airplanko, Bernd Michalak, Oberhausen  
 Airvalve Flow Control GmbH, Unna  
 Albutec GmbH, Rostock  
 ALPINE-ENERGIE Deutschland GmbH, Biberach  
 ALSTOM GmbH Holding, Frankfurt a. M.  
 Altenburger Maschinen Jäcking GmbH, Hamm  
 Andreas Nanke, Bröckel  
 Andritz AG, Graz, Austria  
 Ansaldo Fuel Cells S.p.A., Genova, Italy  
 Apex Energy Teterow GmbH, Teterow  
 aqua-society GmbH, Herten  
 Aquatec3w GmbH, Dresden  
 Arbeitsgemeinschaft Qualitätsmanagement Biodiesel e. V., Berlin  
 Architektenpartner Reuss & Reuss, Memmelsdorf  
 ARGE Deponiegasbetrieb Buchschlag HOCHTIEF - Rytec, Frankfurt a. M.  
 ASZ GmbH & Co. KG, Bad Rappenau  
 A-TEC Anlagentechnik GmbH, Duisburg  
 AVG Abfall-Verwertungs-GmbH, Hamburg  
 AVH. e.k., Düsseldorf  
 AVIT Hochdruck Rohrtechnik GmbH, Essen  
 Axima Refrigeration GmbH, Lindau (Lake Constance)

#### B

Baerlocher GmbH, Unterschleißheim  
 BASF Aktiengesellschaft, Ludwigshafen  
 Bau- und Liegenschaftsbetrieb NRW Dortmund  
 Bayer AG, Leverkusen  
 Bayer Technology Services GmbH, Leverkusen  
 BAYERNOIL Raffinerieges. mbH, Ingolstadt  
 benefit GmbH, Hirschau  
 Beschäftigungs- und Qualifizierungsgesellschaft Werkhof gem. Gm, Hagen  
 BGA Entwicklungs-Verwaltungsges. mbH, Willich  
 BHC-Gummi-Metall GmbH, Meckenheim  
 Biodiesel Sternberg GmbH & Co. KG, Sternberg  
 Bioenergie Steinfurt GmbH & Co. KG, Steinfurt  
 BioKraft Südpfalz GmbH & Co. KG, Freckenfeld  
 Biomasse Heizkraftwerk Eisenberg GmbH, Recklinghausen  
 Biomasse-Kraftwerk Güssing GmbH, Güssing  
 Biomind, Fröndenberg/Ruhr  
 Biostadt Hennstedt GmbH & Co. KG, Hennstedt  
 BIOXY B.V., S'-Gravenhage, Netherlands  
 BKT Energietechnik GmbH, Oberhausen  
 Borealis GmbH, Linz, Austria  
 Britta Loick Consulting GmbH, Dorsten  
 Brunel GmbH, Mannheim  
 Buchhandlung und Verlag K.-M. Laufen, Oberhausen

Bückmann GmbH, Mönchengladbach  
 build.ing Gesellschaft für Planen, Bauen, Betreuen mbH, Berlin  
 Bundesamt für Bauwesen und Raumordnung, Berlin  
 Bundesamt für Wirtschaft und Ausfuhrkontrolle (BAFA), Eschborn  
 Bundesamt für Zivildienst, Cologne  
 Bundesministerium für Bildung und Forschung, Berlin  
 Bundesministerium für Umwelt, Naturschutz und Reaktorsicherheit, Berlin  
 Bundesministerium für Verbraucherschutz, Ernährung und Landwirtschaft, Bonn  
 Bundesministerium für Wirtschaft und Arbeit, Bonn  
 Bundesrepublik Deutschland, Bonn  
 Büro für Technikfolgen-Abschätzung beim Deutschen Bundestag (TAB), Berlin  
 BWS Technologie GmbH, Grevenbroich

#### C

Caritas Wohn- und Werkstätten Niederrhein GmbH, Moers  
 Carl Bechem GmbH, Hagen  
 Cartomat Spezialkartons GmbH, Willich  
 Centro de Investigación de Polímeros Avanzados (CIPA), Concepción, Chile  
 CentroO. Management GmbH, Oberhausen  
 CHEMEC GmbH Ingenieurbüro für Chemo-Messtechnik, Bielefeld  
 Chemion Logistik GmbH, Bayer Chemiepark, Geb. R8, Bereich Häfen, Krefeld  
 Ciba Spezialitätenchemie Lampertheim GmbH, Basel, Switzerland  
 Centrum für internationale Migration und Entwicklung (CIM), Frankfurt a. M.  
 Clariant GmbH, Hürth  
 Coocon Club GmbH & Co. KG, Frankfurt  
 Cornpack GmbH & Co. KG, LOICK Biowertstoffe, Teterow  
 Cornpack GmbH & Co. KG, Dorsten  
 Creative Concepts & Projects Establishment (CC &P), Schaan, Liechtenstein

#### D

DaimlerChrysler AG, Berlin  
 DaimlerChrysler AG, Stuttgart  
 DAS Ingenieurbüro GmbH, Deponie Anlagen Stachowitz, Kiel  
 DataPool engineering GmbH, Oberhausen  
 DECHEMA e. V., Frankfurt a. M.  
 Degussa AG, Frankfurt a. M.  
 Deloro Stellite GmbH, Koblenz  
 DELU AG, Gladbeck  
 Deron Systemhaus GmbH, Ostfildern  
 Deutsche Bundesstiftung Umwelt, Osnabrück  
 Deutsche Montan Technologie GmbH (DMT), Essen  
 Deutsche Rockwool-Mineralwoll GmbH & Co. oHG, Gladbeck  
 Deutsche Steinkohle AG, Herne  
 Deutscher Bundestag, Berlin  
 DEUTZ Power Systems GmbH & Co. KG, Mannheim  
 Di Matteo Förderanlagen GmbH & Co. KG, Beckum

DKR Deutsche Gesellschaft für Kunststoff-Recycling mbH, Cologne  
 DLR Deutsches Zentrum für Luft- und Raumfahrt, Bonn  
 Dr. Ing. h. c. F. Porsche AG, Stuttgart  
 Dr.-Ing. habil. Brachetti, Springe  
 Drewag Stadtwerke Dresden GmbH, Dresden  
 DVGW Deutscher Verein des Gas- u. Wasserfaches e. V. twV, Bonn

#### E

E. J. M. Abbenhaus GmbH, Clausthal-Zellerfeld  
 E.On Engineering GmbH, Gelsenkirchen  
 E.ON Ruhrgas AG, Essen  
 EADS Deutschland GmbH Forschung, Munich  
 EBRO Armaturen Gebr. Bröer GmbH, Hagen  
 eclareon GmbH, Berlin  
 EcoEnergy Gesellschaft für Energie- und Umwelttechnik mbH, Walkenried  
 Ecoprog e. K., Cologne  
 ECS-Environmental Consulting & Service GmbH, Willich  
 emano Kunststofftechnik GmbH, Teterow  
 Emil Lihotzky Maschinenfabrik, Patting  
 Emissions-Trader ET GmbH, Alpen  
 Energieversorgung Gera GmbH, Gera  
 Energieversorgung Oberhausen AG, Oberhausen  
 EPEB GmbH, Sonthofen  
 ERNST KOCH GmbH & Co. KG, Hemer  
 ESP-Chemie, Premnitz  
 EUS Gesellschaft für innovative Energiewandlung und -speicherung mbH, Gelsenkirchen  
 EUS GmbH, Dortmund  
 EVD Entwicklungsgesellschaft für Verbundmaterial Diez mbH, Diez

#### F

Fachhochschule Niederrhein, Krefeld  
 FarmTech Beteiligungs-GmbH, Dorsten  
 FEBA - Forschung und Engineering für biotechn. Anwendungen GmbH, Willich  
 Felix Schoeller Foto- und Spezialpapiere GmbH & Co. KG, Osnabrück  
 FernUniversität in Hagen, Hagen  
 Fernwärme-Forschungsinstitut e. V. FFI, Hemmingen  
 Fernwärmeversorgung Niederrhein GmbH, Dinslaken  
 Filterwerk Mann+Hummel GmbH, Ludwigsburg  
 FITR e. V., Weimar  
 FKUR Kunststoff GmbH, Willich  
 Flughafen Düsseldorf GmbH, Düsseldorf  
 FNR Fachagentur nachwachsende Rohstoffe e. V., Gülzow  
 Forschungszentrum Karlsruhe GmbH, Außenstelle Dresden  
 Forschungszentrum Jülich GmbH, Jülich  
 Frey & Lau GmbH, Henstedt-Ulzburg

#### G

G. A. S. Gesellschaft für Antriebs- u. Steuertechnik mbH, St. Georgen  
 G.A.S. Energietechnologie GmbH, Krefeld  
 Gämmerler AG, Geretsried  
 Gartenbauzentrum Straelen Landwirtschaftskammer NRW, Straelen  
 GDV Automotive Rehburg GmbH & Co. KG, Rehburg-Loccum

## Selected Clients, Contacts and Circle of Friends and Patrons

GE Bayer Silicones GmbH & Co. KG, Leverkusen  
 GE Healthcare Bio-Sciences, Freiburg im Breisgau  
 GE Jenbacher Spain & Portugal, San Sebastián de los Reyes, Spain  
 GEA Happel Systems Engineering GmbH, Herne  
 GEA Luftkühler GmbH, Bochum  
 GEBA Kunststoffcompounds GmbH, Ennigerloh  
 Gesellschaft für Anlagenbau und Service (GEfAS), Oberhausen  
 Gesthuysen, von Rohr & Eggert, Essen  
 GfEM Ges. für Energiemanagement mbH, Berlin  
 GIGATON GmbH, Viernheim  
 GKT Gummi- und Kunststofftechnik Fürstenwalde GmbH, Fürstenwalde/Spree  
 Gleitsmann Security Inks GmbH, Berlin  
 Goldschmidt GmbH, Essen  
 Groep Machiels Recycling Technology, Wilsel-Leuven, Netherlands  
 Günter Schulze Düding, Steinfurt  
 GWE Wärme- und Energietechnik GmbH, Osterode am Harz  
 GWI - Gaswärme-Institut e. V., Essen

### H

H. Angers Söhne Bohr- und Brunnenbauges. mbH, Hessisch Lichtenau  
 Haas Anlagenbau GmbH, Chieming  
 Hahn Kunststoffe GmbH, Hahn-Flughafen  
 Harald Egner, Fraunhofer TEG, Melton Mowbray, Great Britain  
 Harmuth Entsorgung GmbH, Mülheim a. d. R.  
 Hauni Maschinenbau AG, Hamburg  
 Haus der Technik e. V., Essen  
 Haus Vogelsang GmbH, Datteln  
 Heine Gesellschaft für schlüsselfertiges Bauen, Oberhausen  
 Heinrich Fahlenkamp GmbH & Co. KG, Bruchhausen-Vilsen  
 Heinrich Grünewald GmbH & Co. KG Bauunternehmung, Oberhausen  
 Helsa-Werke Helmut Sandler GmbH & Co. KG, Gefrees  
 Henkel KGaA, Düsseldorf  
 Hennecke GmbH, Sankt Augustin  
 Herr Dipl.-Ing. Wolfgang Thaler, Kempen  
 Hertener Stadtwerke GmbH, Herten  
 Hobart GmbH, Offenburg  
 Hosokwa Micron GmbH, Cologne  
 Hubert Loick VNR GmbH, Dorsten  
 Humana Milchunion eG, Herford  
 Hündgen Entsorgung GmbH & Co. KG, Swisttal  
 Hüttenwerke Krupp Mannesmann GmbH, Duisburg  
 HV Umweltservice GmbH, Swisttal-Ollheim

### I

IBBau - Illertaler Biomasse Bau- und Eigentums GmbH & Co. KG, Stuttgart  
 imat - ue gmbh, Mönchengladbach  
 Immobilien Strebersdorf Verwaltungsgesellschaft m.b.H., Vienna, Austria  
 Impreglon AG, Lüneburg  
 INEOS Phenol GmbH & Co. KG, Gladbeck  
 Innovatherm Gesellschaft zur innovativen Nutzung von Brennstoffen mbH, Lünen  
 Institut für Energetik und Umwelt GmbH, Leipzig

Intensiv-Filter Deutschland GmbH & Co. KG, Velbert  
 Interessenverband Grubengas IVG e. V., Duisburg  
 INTERMET Neunkirchen GmbH, Neunkirchen  
 Intier Automotive Eybl Interiors GmbH, Straubing  
 Invenio Kunststoffe Engineering GmbH, Erwitte  
 ISO-mk Innovation, Finowfurt  
 Itasca Consults GmbH, Gelsenkirchen  
 IUQ Dr. Krengel GmbH, Grevesmühlen

### J

Jenbacher AG, Jenbach  
 Jesco GmbH, Wedemark  
 Johnson Controls Interiors GmbH & Co. KG, Grefrath  
 Josef Baust Holzbetriebs GmbH, Eslohe

### K

Karsten Pueschner, Hartmannsdorf-Reiche  
 KEC Kölbl Engineering und Consulting GmbH, Kamp-Lintfort  
 KHT Fahrzeugteile GmbH, Grevenbroich  
 Kiriaki Michaludi, Nikiti, Greece  
 Kluber Lubrication Benelux SA, Dottignies, Belgium  
 Knippers-Metall-Chemie oHG, Mülheim a. d. R.  
 Kommission der europäischen Union, Brussels, Belgium  
 KonnexX Unternehmensberatungsgesellschaft mbH, Güstrow  
 Kreis Recklinghausen, Recklinghausen  
 Kreisverwaltung Neuwied, Linkenbach

### L

Lakufol Kunststoffe GmbH, Henfenfeld  
 Landesumweltamt Nordrhein-Westfalen, Essen  
 Landgericht Heilbronn, Heilbronn  
 Landgericht Mannheim, 7. Zivilkammer, Mannheim  
 Landwirtschaftlicher Ortsverein Burgsteinfurt e. V., Steinfurt  
 LBD-Beratungsgesellschaft mbH, Berlin  
 LEG Standort- und Projektentwicklung Köln GmbH, Cologne  
 Lichtwer Pharma GmbH, Berlin  
 Linz Gas/Wärme AG, Linz  
 Lippeverband, Essen  
 LITZEN Wärme-Beratung KG, Neuss  
 LLS Standardkessel Service GmbH, Duisburg  
 Logo tape Gesellschaft für Selbstklebebänder mbH & Co. KG, Harrislee  
 Loick AG für nachwachsende Rohstoffe, Dorsten  
 Loick Bioenergie GmbH, Dorsten  
 LÜNTEC Förderverein e. V., Lünen  
 Lurgi Metallenergie GmbH, Oberursel  
 Lurgi Metallurgie GmbH für Forschung und Entwicklung, Frankfurt a. M.

### M

Machinefabriek Dimnissen BV, Sevenum, Netherlands  
 Mainova AG, Frankfurt a. M.  
 Malvern Instruments GmbH, Herrenberg  
 MAN Ferrostaal AG, Project Development Eastern Europe (VO), Essen  
 MAN Turbomaschinen AG, Oberhausen

Mark-E AG, Hagen  
 MAT-Tec Engineering GmbH, Willich  
 Mehldau & Steinfath Umweltechnik GmbH, Essen  
 Membrana GmbH, Wuppertal  
 Messe Frankfurt GmbH, Frankfurt a. M.  
 Messer Griesheim Dritte Vermögensverwaltungs-GmbH  
 Metall-Technik GmbH, Oberhausen  
 MGT Maschinen- und Gerätebau GmbH, Groß Wokern  
 Microdyn-Nadir GmbH, Wuppertal  
 Mingas-Power GmbH, Essen  
 Ministerium für Innovation, Wissenschaft, Forschung und Technologie des Landes Nordrhein-Westfalen, Düsseldorf  
 Modernbau GmbH, Saarbrücken  
 MSA AUER GmbH, Berlin  
 MVA Bielefeld-Herford GmbH, Bielefeld

### N

N.V. VAM, Wijster, Netherlands  
 National-Bank AG, Oberhausen  
 Nature Environmental Worldwide Technologies GmbH NEW Tec, Dortmund  
 Novem Netherlands agency for energy and the environment, Sittard, Netherlands  
 NRW.BANK, Düsseldorf

### O

o.m.p. Optische Mess- und Prüftechnik GmbH, Bochum  
 Omega Minerals Germany GmbH, Norderstedt  
 Oschatz GmbH, Essen  
 Osterhuber Agrar GmbH, Gut Ferdinandshof, Heinrichswalde  
 Osterhuber Königsholland GbR, Heinrichswalde  
 OTTO QUAFT-Fertigbau Lindenberg GmbH & Co. KG, Freudenberg

### P

Parker Hannifin GmbH & Co. KG, Kaarst  
 PBO Projektentwicklungs- und Beteiligungsgesellschaft Oberhausen mbH, Oberhausen  
 Pergan Hilfsstoffe für industrielle Prozesse GmbH, Bocholt  
 Philips Medizin Systeme GmbH, Hamburg  
 PLAMA Plastic-Maschinen GmbH, Haan  
 Polyplast Müller GmbH, Straelen  
 Pressko AG, Artern  
 Privatbrauerei Moritz Fiege GmbH & Co. KG, Bochum  
 Pro Asia Consulting Office, Oberhausen  
 pro2 Anlagentechnik GmbH, Willich  
 Procter & Gamble Central & Eastern Europe GmbH, Schwalbach am Taunus  
 Pur Technologie, Munich  
 PUR-Technologie Hegemann, Essen  
 purus Niedergebra GmbH, Niedergebra

### R

Raedlinger Maschinen- und Anlagenbau GmbH, Cham  
 RAG Verkauf GmbH, Essen  
 Ralf Hacker, Hüllhorst  
 Ralf Hacker Edelstahl, Löhne  
 Ralf Müller, Viersen

## Selected Clients, Contacts and Circle of Friends and Patrons

RATIONAL Technische Lösungen GmbH, Rostock  
 Rethmann Lippewerk GmbH, Lünen  
 Reuschel-Systemtechnik-GmbH, Büren  
 Rhein-Plast GmbH, Bad Dürkheim  
 RJR Consultores Asociados & Eventos,  
 Sao Paolo, Brazil  
 RKW Thüringen GmbH, Erfurt  
 Robert Bosch GmbH, Stuttgart  
 Ronald Hegemann, Hattingen  
 Ruhr-Universität Bochum, Fakultät für Maschi-  
 nenbau, Lehrstuhl für Verfahrenstechnische  
 Transportprozesse, Bochum  
 RÜTGERS CarboTech GmbH, Essen  
 RWE Power AG, Essen  
 RWTH Aachen, Aachen  
 RWTÜV Systems GmbH, Essen

## S

Sachtleben Chemie GmbH, Duisburg  
 SAG Netz- und Energietechnik GmbH, Langen  
 Sahnemolkerei H. Wiesehoff GmbH, Schöppingen  
 Schering Africa GmbH, Berlin  
 Schering AG, Bergkamen  
 Schüttgutveredelung Noll GmbH, Bobingen  
 Sesterhenn Energiedienstleistungen, Titz  
 SET 2000 GmbH, Oberhausen  
 Silcarbon Aktivkohle GmbH, Kirchhundem  
 SILOXA Engineering AG, Essen  
 Silver-Plastics GmbH & Co. KG, Troisdorf  
 SMS Mevac GmbH, Essen  
 Solvay Barium Strontium GmbH, Hannover  
 Spezialitäten-Käserei De Lucia GmbH, Heiden  
 Spreerelast AG & Co. KG, Vetschau/Spreewald  
 Staatskanzlei des Landes NRW, Düsseldorf  
 Stadt Duisburg  
 Stadt Frankfurt a. M.  
 Stadt Moers  
 Stadt Oberhausen  
 Stadt Pfaffenhofen a. d. Ilm  
 Stadt Teterow  
 Stadtparkasse Oberhausen  
 Stadtwerke Annaberg-Buchholz Energie AG  
 Stadtwerke Bochum GmbH  
 Stadtwerke Dinslaken GmbH  
 Stadtwerke Duisburg AG  
 Stadtwerke Flensburg GmbH  
 Stadtwerke Gießen AG  
 Stadtwerke Herne AG  
 Stadtwerke Kiel AG  
 Stadtwerke Strausberg GmbH  
 Stadtwerke Worms  
 Standard-Kessel Gesellschaft Lentjes-Fasel  
 GmbH & Co. KG, Duisburg  
 Stankiewicz GmbH, Adelheidsdorf  
 Stenau Entsorgungs- und Kreislaufwirtschaft  
 GmbH & Co. KG, Ahaus  
 Stiftung Liebenau, Ravensburg  
 Stockhausen GmbH & Co. KG, Krefeld  
 Südwestdeutsche Salzwerte AG, Heilbronn  
 swb Erzeugung GmbH & Co. KG, Bremen

## T

Technamotion Technical Europe GmbH, Aachen  
 Technische Universität Bergakademie Freiberg,  
 Freiberg  
 Technische Werke Ludwigshafen am Rhein AG,  
 Ludwigshafen a. R.

Technolice AG, Mägenwil, Switzerland  
 Technopool Schwimmbadtechnologie GmbH,  
 Osnabrück  
 Tenax Fibers GmbH, Heinsberg  
 Theodor Heimeier Metallwerk Beteiligungsges.  
 mbH, Erwitte  
 Thyssen Edelstahlwerke AG, Krefeld  
 ThyssenKrupp Stahl AG, Duisburg  
 TODA Kogyo Europe GmbH, Düsseldorf  
 Tönsmeier Entsorgung Beteiligungs-GmbH,  
 Porta Westfalica  
 Tricat Zeolites GmbH, Bitterfeld  
 TÜV Industrie Service GmbH, TÜV Süd Gruppe,  
 Mönchengladbach

## U

Uhde GmbH, Dortmund  
 Unidad de desarrollo tecnologico de la  
 universidad de concepción, Chile  
 Universität Dortmund, Dortmund  
 Universität Essen, Lehrstuhl für Umweltverfahrens-  
 technik und Anlagentechnik, Essen  
 Universität Stuttgart, Stuttgart  
 Urenco Deutschland GmbH, Jülich  
 Uwe Glien, Berlin

## V

Valorec Services AG, Basel, Switzerland  
 Verein Deutscher Ingenieure e. V. (VDI),  
 Düsseldorf  
 Verein für ZukunftsEnergie-Systeme, Saarbrücken  
 Verein zur Förderung der Energie- und Umwelt-  
 technik e. V. - VEU, Duisburg  
 Verein zur Förderung der Umwelt-, Sicherheits- u.  
 Energietechnik e. V., Oberhausen  
 Veritas Medizintechnik GmbH, Halberstadt  
 Via et Finis sp.z.o.o., Bialogard, Poland  
 Vodafone D2 GmbH, Düsseldorf  
 Volkswagen AG, Wolfsburg  
 voltwerk AG, Hamburg  
 Vorwerk Elektrowerke GmbH & Co. KG,  
 Wuppertal

## W

Wacker Chemie GmbH, Munich  
 WAGRO Systemdichtungen GmbH, Dortmund  
 WEHRLE WERK AG, Emmendingen  
 Weichkäserei Altenburger Land GmbH & Co. KG,  
 Lumpzig  
 WEKA MEDIA GmbH & Co. KG, Kissing  
 Westfalia Separator AG, Oelde  
 WETEC Elektrotechnik GmbH, Moers  
 wlf plastic GmbH, Lüdenscheid  
 WIKA Alexander Wiegand GmbH & Co. KG,  
 Klingenberg a. M.  
 Wirtschaftsministerium des Landes Mecklenburg-  
 Vorpommern, Schwerin  
 WLW-Service GmbH, Borken

## Z

Zeppelin Baumaschinen GmbH, Achim  
 Zweckverband Abfallbeseitigung Mülldeponie  
 Kahlenberg, Ringsheim

# Patents

## Patents 2005

### Issued Patents:

Network-based information system and process for the centralized administration and up-dating of data objects with changing content (Hübner) – Germany

Method for modifying the surfaces of fine-porous adsorbents (Weber, Guderian, Jelen, Heil) – Germany, Europe

Method for Producing Shaped Activated Charcoal (Guderian, Heil, Horn, Feseker, Sohnemann) – USA

Demonstration device modeling a living organism (Weinspach) – Ukraine, Czech Republic

Modular chemical micro reaction system and process (Panitzky, Deerberg) – Germany

Method for the stepped combustion of fuel (Wolf, Keldenich) – Germany, Europe

Integrated immobilisate processing (Wack, H. Deerberg, Bergstedt, Büchs\*, Heinemann\*, Ansorge-Schumacher\*) – Germany

Device for the anaerobic cleaning of waste water (Krassowski) – Germany

Method for treating flue gases containing ammonia (Wolf, Keldenich, Marzi, Toda\*, Imai\*) – Europe

Process for converting raw materials and waste materials containing oil or fat into a mixture containing a high proportion of hydrocarbons, products produced by this method and their application (Cinquemani, Heil, Jakob, Weber) – Germany

\* = external inventors

### Registered trademarks:

Rodentics (word trademark)



## Spin-offs Circle of Friends and Patrons

### Spin-offs

**AIROX GmbH, Alpen**  
Systems for oxygenation  
www.airox.de

**Andreas Schröder IT-Consulting GmbH, Schermbeck**  
Counseling and service in the area of information and telecommunication technologies

**A-TEC Anlagentechnik GmbH, Duisburg**  
Innovative solutions concerning coal mine gas; hazard prevention: analyses, extraction, safety concepts; utilization for power and heat generation: energy concepts, design and operation of plants  
www.atec.de

**DataPool Engineering GmbH, Oberhausen**  
Software development, system analyses, EDP-consulting  
www.dp-e.de

**Emissions-Trader ET GmbH, Alpen**  
Emissions trading  
www.emissions-trader.de

**FKuR Kunststoff GmbH, Willich**  
Innovative solutions concerning plastics and recycling; comminution technology; extrusion, injection molding; elastomer recycling; material analyses; test technology; recycling concepts  
www.fkur.de

**IDESYS Ingenieurgesellschaft für dezentrale Energiesysteme mbH, Oberhausen**  
Planning, development, production, installation of local energy systems and plants  
www.idesys.de

**invenio KUNSTSTOFF ENGINEERING, Erwitte**  
Product development and optimization of plastics components with numerical analyses; FEM structure analyses; injection molding analyses; construction  
www.invenio.net

**VENTAX Big-Bag Network GmbH & Co. KG, Willich**  
Big-Bag cleaning facilities, reusable Big-Bag, packaging systems  
www.ventax.de

**WAGRO Systemdichtungen GmbH, Dortmund**  
Swellaible polymere seals; sewer and building refurbishment; consultation, planning, and implementation; development and production of sealing systems (area of application: engineering and pipeline construction)  
www.wagro-systemdichtungen.de

### UMSICHT Circle of Friends and Patrons

#### Members of the UMSICHT Circle of Friends and Patrons

- AGR mbH
- AVIT GmbH
- Buchhandlung und Verlag K.-M. Laufen
- DECHEMA e. V.
- Energieversorgung Oberhausen AG
- Fernwärme - Forschungsinstitut in Hannover e. V. FFI
- Fernwärmeversorgung Niederrhein GmbH
- FITR e. V.
- FKUR GmbH
- Heine Gesellschaft für schlüsselfertiges Bauen mbH
- Heinrich Grünwald GmbH & Co. KG
- KonnexX Unternehmensberatungsgesellschaft mbH
- Loick Bioenergie GmbH
- LÜNTEC Förderverein e. V.
- National-Bank AG
- PUR-Technologie-Hegemann
- Sesterhenn Energiedienstleistungen Titz
- Stadtparkasse Oberhausen
- Verein zur Förderung der Energie- und Umwelttechnik e. V.
- WAGRO Systemdichtungen GmbH

#### Membership in the UMSICHT Circle of Friends and Patrons

»Verein zur Förderung der Umwelt-, Sicherheits- und Energietechnik e. V.«  
**(UMSICHT Circle of Friends and Patrons)**

Osterfelder Strasse 3 • 46047 Oberhausen • Germany  
Phone +49 2 08/85 98 -0 • Fax +49 2 08/85 98 -12 90

The UMSICHT Circle of Friends and Patrons supports measures that strengthen the role of Fraunhofer UMSICHT in the R&D market and supports projects by providing ideas and financial assistance. As a result, established and new businesses receive access to competitive and sustainable technology developments.

Yes, I am interested in the UMSICHT Circle of Friends and Patrons. Please send me additional information.

## How to Find Us

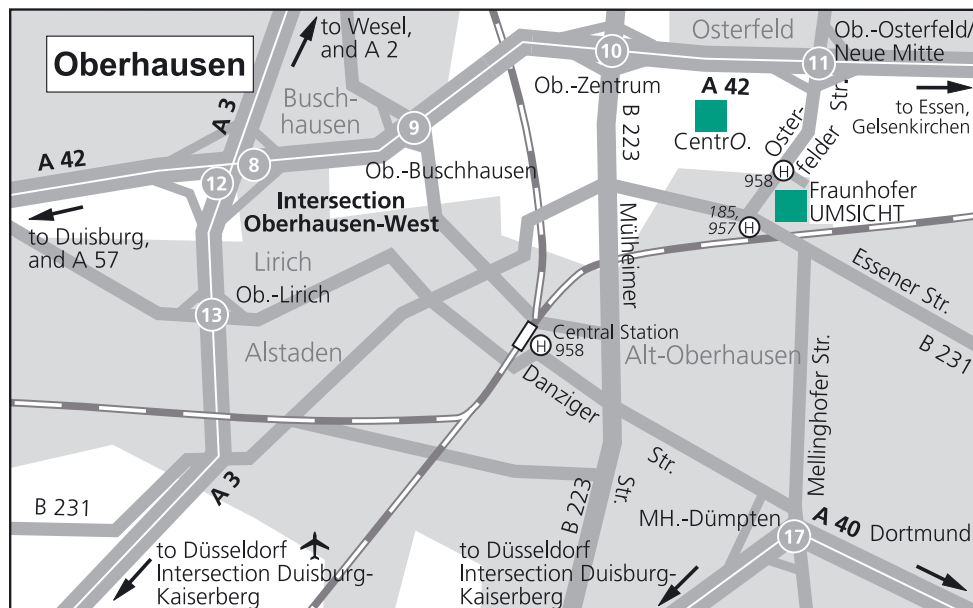

### By car

Freeway A42

*coming from Dortmund:*

Exit Oberhausen-Osterfeld/Neue Mitte. Go straight forward onto Osterfelder Strasse. Follow Osterfelder Strasse towards "Neue Mitte Oberhausen" or "Oberhausen-Zentrum/Essen" respectively. After approximately 1.5 kilometers (behind the sign "Fraunhofer UMSICHT") turn left on the institute's parking lot.

*coming from Duisburg:*

Exit Oberhausen-Osterfeld/Neue Mitte. Turn right at the end of the exit onto Osterfelder Strasse towards "Neue Mitte" or "Oberhausen-Zentrum/Essen" respectively. To continue please follow the instructions above.

Freeway A40

*coming from Dortmund:*

Exit Mülheim-Dümpten. Turn right at the end of the exit. At the next intersection turn left onto Mellinghofer Strasse and at its end turn left onto Essener Strasse. At the next major intersection turn right onto Osterfelder Strasse. At the first traffic lights turn right into the institute's parking lot.

*coming from Duisburg:*

Exit Mülheim-Dümpten. Turn left at the end of the exit. At the next intersection turn left onto Mellinghofer Strasse. To continue please follow the instructions above.

### By train

From Oberhausen Hauptbahnhof either with bus number 185 (towards Essen Borbeck Bf.) to Fraunhofer UMSICHT, 957 (towards Oberhausen Sterkrade Bf.) or 958 (towards Oberhausen Spechtstraße), exit at the stop »UMSICHT«.

### By plane and train/car

From Düsseldorf Airport terminal A/B take the Skytrain to Düsseldorf Airport Station, then change to the Regional Express to Hamm or Wesel respectively. Leave the train at Oberhausen central station; to continue see: By train or if you are traveling by car take Freeway A 44 from the airport till you reach intersection "Düsseldorf-Nord". Take freeway A 52 (direction Essen/Oberhausen). At intersection "Breitscheid" change onto freeway A 3 and keep going until you get to intersection "Oberhausen West"; From there turn onto freeway A 42 (direction "Dortmund") and take the exit "Oberhausen-Osterfeld/Neue Mitte"; to continue see: by car.

### Adress

Fraunhofer Institute for Environmental, Safety, and Energy Technology UMSICHT

### Director:

Prof. Dr.-Ing. Eckhard Weidner

### Director Science and Technology:

Dr.-Ing. Görgo Deerberg

Osterfelder Strasse 3  
46047 Oberhausen  
Germany

Phone: + 49 2 08/85 98 -0

Fax: + 49 2 08/85 98 -12 90

Website: [www.umsicht.fraunhofer.de](http://www.umsicht.fraunhofer.de)

E-mail: [info@umsicht.fraunhofer.de](mailto:info@umsicht.fraunhofer.de)

Your way to us online:

[www.umsicht.fhg.de/profil/anfahrt/index.php](http://www.umsicht.fhg.de/profil/anfahrt/index.php)

# Guidelines

The guidelines of the organization "Fraunhofer UMSICHT" describe the basic self-conception of the Institute and its staff. Therefore, they are kept in a general form and build a frame which is to be completed and acted out but which also is to be advanced.

Guidelines are to bring continuity and stability into dynamically changing requirements of environment and daily routine. They are to accompany the institute's work beyond office hours and are to

be communicated inside and outside the institute. Thus, mission, policies, and expectations the institute operates with and wants to be perceived with in its surroundings with are reflected in the guidelines.

The ten guidelines of the organization "Fraunhofer UMSICHT" are deduced from the regulations and guidelines of the "Fraunhofer Gesellschaft" and concretize them for the concerns of the institute's work.

- 1 Fraunhofer UMSICHT sees itself as a link between its business partners, staff members, the "Fraunhofer Gesellschaft", the scientific community, and other social actors.
- 2 Fraunhofer UMSICHT wants to be a reliable research and development partner for its clients, relieve them during all project phases, give them all respective services from one hand, and support them in accessing subsidies and commercial funding.
- 3 Fraunhofer UMSICHT offers its clients high-quality scientific, results-oriented, interdisciplinary, and innovative research and development work. It provides them with competitive advantages through advance in know-how and recognized competence in problem solving.
- 4 The staff members form the institute's backbone. Fraunhofer UMSICHT encourages and challenges the staff's professional, scientific, entrepreneurial, and social skills. These skills determine the institute's efficiency. Fraunhofer UMSICHT wants to fill its staff with enthusiasm for research and development.
- 5 Fraunhofer UMSICHT acts according to the principles of the "Fraunhofer Gesellschaft" and contributes to enhancing the reputation of the "Fraunhofer Gesellschaft". The institute cooperates in partnership with the board of directors, headquarters, and other Fraunhofer institutes and facilities.
- 6 Fraunhofer UMSICHT is actively committed to the formation of strategic alliances and networks in economy, science, politics, and society.
- 7 Fraunhofer UMSICHT forces up activities abroad in respect of project work and exchanging staff members (know-how transfer).
- 8 Fraunhofer UMSICHT acts actively in the scientific community. The institute cooperates with other research facilities, universities, technical colleges, and industrial partners in the national and international research and development scene, and faces up to scientific debate.
- 9 Fraunhofer UMSICHT is independent. It supports clear, understandable, and interdisciplinary consolidated positions and aligns its objectives according to these positions. Fraunhofer UMSICHT aims at a long-term realization of social visions through concrete innovations which can be efficiently transferred into economically utilizable progress and can be transferred into the environment.
- 10 Fraunhofer UMSICHT sees itself as a pathfinder for technical changes in the areas of environment, energy, process engineering, and safety. The institute promotes effective management, environmentally friendly technologies, and environmentally conscious behavior in order to enhance society's overall quality of life.



# Guidelines

## The Fraunhofer-Gesellschaft

# The Fraunhofer-Gesellschaft

The Fraunhofer-Gesellschaft undertakes applied research of direct utility to private and public enterprise and of wide benefit to society. Its services are solicited by customers and contractual partners in industry, the service sector and public administration. The organization also accepts commissions and funding from German federal and Länder ministries and government departments to participate in future-oriented research projects with the aim of finding innovative solutions to issues concerning the industrial economy and society in general.

By developing technological innovations and novel systems solutions for their customers, the Fraunhofer Institutes help to reinforce the competitive strength of the economy in their local region, and throughout Germany and Europe. Through their work, they aim to promote the successful economic

development of our industrial society, with particular regard for social welfare and environmental compatibility.

As an employer, the Fraunhofer-Gesellschaft offers its staff the opportunity to develop the professional and personal skills that will allow them to take up positions of responsibility within their institute, in other scientific domains, in industry and in society.

At present, the Fraunhofer-Gesellschaft maintains some 80 research units, including 58 Fraunhofer Institutes, at over 40 different locations in Germany. The majority of the roughly 12,500 staff are qualified scientists and engineers, who work with an annual research budget of over 1 billion euros.

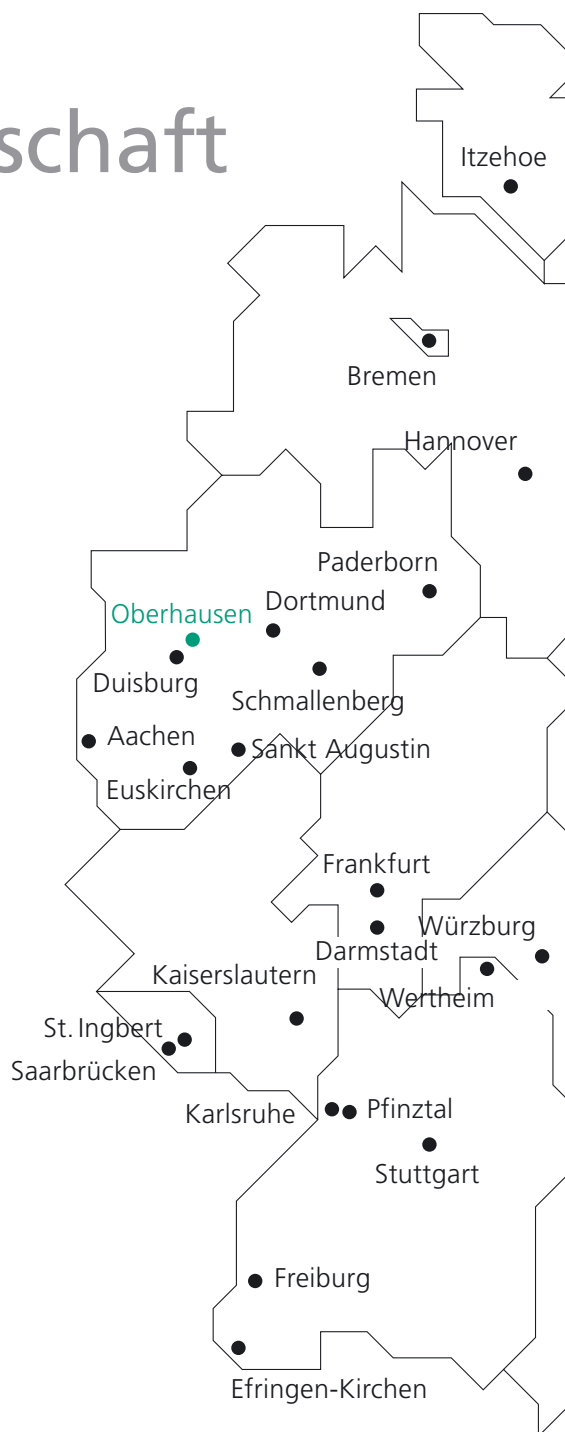

## The Fraunhofer-Gesellschaft

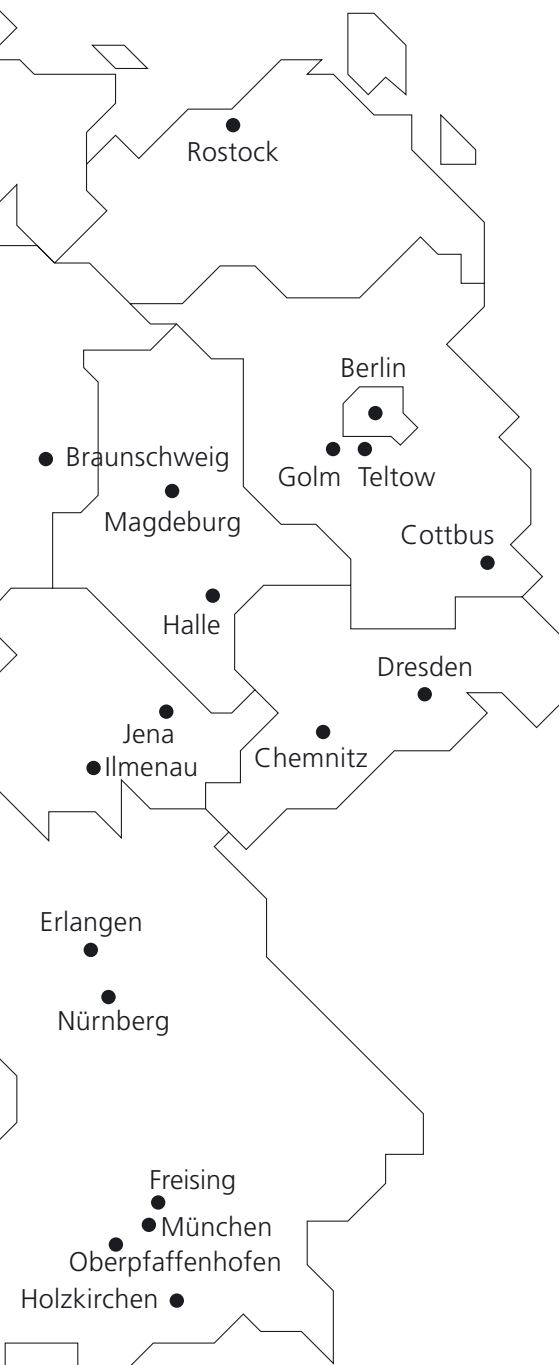

Of this sum, more than €900 million is generated through contract research. Roughly two thirds of the Fraunhofer-Gesellschaft's contract research revenue is derived from contracts with industry and from publicly financed research projects. The remaining one third is contributed by the German federal and Länder governments, partly as a means of enabling the institutes to pursue more fundamental research in areas that are likely to become relevant to industry and society in five or ten years' time.

Affiliated research centers and representative offices in Europe, the USA and Asia provide contact with the regions of greatest importance to present and future scientific progress and economic development.

The Fraunhofer-Gesellschaft was founded in 1949 and is a recognized non-profit organization. Its members include well-known companies and private patrons who help to shape the Fraunhofer-Gesellschaft's research policy and strategic development.

The organization takes its name from Joseph von Fraunhofer (1787-1826), the illustrious Munich researcher, inventor and entrepreneur.

## Board of Trustees – Fraunhofer UMSICHT

### Trustees



Ernst Gerlach  
Chairman  
(NRW.BANK, Member of  
the board, Düsseldorf)



Hubert Loick  
Deputy Chairman  
(Loick Holding AG, Chairman of  
the board, Dorsten)



Burkhard Drescher  
(RAG Immobilien AG,  
Member of the board,  
Essen)



Dr. Jochen Hamatschek  
(Westfalia Separator  
Food Tec GmbH,  
Managing Director, Oelde)



Prof. Dr.-Ing. Helmut Hoyer  
(FernUniversität in Hagen,  
Rektor, Hagen)



Dr.-Ing. Harald Irmer  
(Environment Agency NRW,  
President, Essen)



Dr.-Ing. Gerd Jäger  
(RWE Power AG, Member of  
the board, Essen)



Dr.-Ing. Karl-Ulrich Köhler  
(ThyssenKrupp Stahl AG,  
Chairman of the board,  
Duisburg)



Dr.-Ing. Thomas Mathenia  
(Energieversorgung Oberhausen AG,  
Member of the board, Oberhausen)



Prof. Dr.-Ing. Thomas Melin  
(RWTH Aachen, Head of Chair I and  
the Institute of Process Engineering  
of RWTH Aachen, Aachen)



Prof. Dr.-Ing. Volker Pilz  
(Bayer AG, Director for Security  
of Site Services/retired since 8/2002,  
Leverkusen)



Dr. rer. nat. Franz-Josef Renneke  
(Schering AG, Plant Manager,  
Bergkamen)



Prof. Dr.-Ing. Viktor Scherer  
(Ruhr-University Bochum, Faculty of  
Mechanical Engineering, Dean, Bochum)



Dr.-Ing. Andreas Schütte  
(Agency of Renewable Resources [FNR]  
e. V., Managing Director, Gülzow)



Ernst Schwanhold  
(BASF Aktiengesellschaft, Head of the  
Competence Center Environment, Energy  
and Safety Technology, Ludwigshafen)



Udo Völker  
(MAN Ferrostaal AG, Chief  
Representative, Essen)

The fourth meeting of the Board of Trustees took place on 28 October 2005 at Fraunhofer UMSICHT in Oberhausen.

## Imprint

### Editing and publishing:

Fraunhofer Institute for  
Environmental, Safety, and  
Energy Technology UMSICHT  
Osterfelder Strasse 3  
46047 Oberhausen  
Germany  
Phone + 49 2 08/85 98 -0  
Fax + 49 2 08/85 98 -12 90

Website [www.umsicht.fraunhofer.de](http://www.umsicht.fraunhofer.de)  
E-mail [info@umsicht.fraunhofer.de](mailto:info@umsicht.fraunhofer.de)

### Editing:

Dr.-Ing. Hartmut Pflaum  
(responsible)  
Iris Kumpmann

### Proof-reading:

Dr. rer. nat. Joachim Danzig  
Manuela Rettweiler, M. A.

### Layout and illustration:

Barbara Vatter  
Daniel Streilein

### Printed by:

Zelle – Der Printspezialist, Düsseldorf

### Sources of photographs:

dortmund-project: p. 7;  
ACCESS e. V.: S. 52  
www.photocase.com:  
Cover, inside cover, p. 8, p. 10, p. 11,  
p. 12, p. 14, p. 22, p. 26-29, p. 32, p.  
33, p. 36, p. 37, p. 40, p. 41, p. 48, p.  
54, p. 65, p. 61, p. 67, p. 70, p. 73, p.  
76, p. 78  
MEV: Cover, p. 15

all other photographs:  
© Fraunhofer UMSICHT

**Copyright:** © Fraunhofer UMSICHT

All rights reserved.

Use of photographs, graphics  
and texts in any form – even in  
extracts – only by previous written  
permission by Fraunhofer UMSICHT

### The Directorate



#### Director:

Prof. Dr.-Ing. Eckhard Weidner



#### Director Science and Technology:

Dr.-Ing. Görgen Deerberg

